

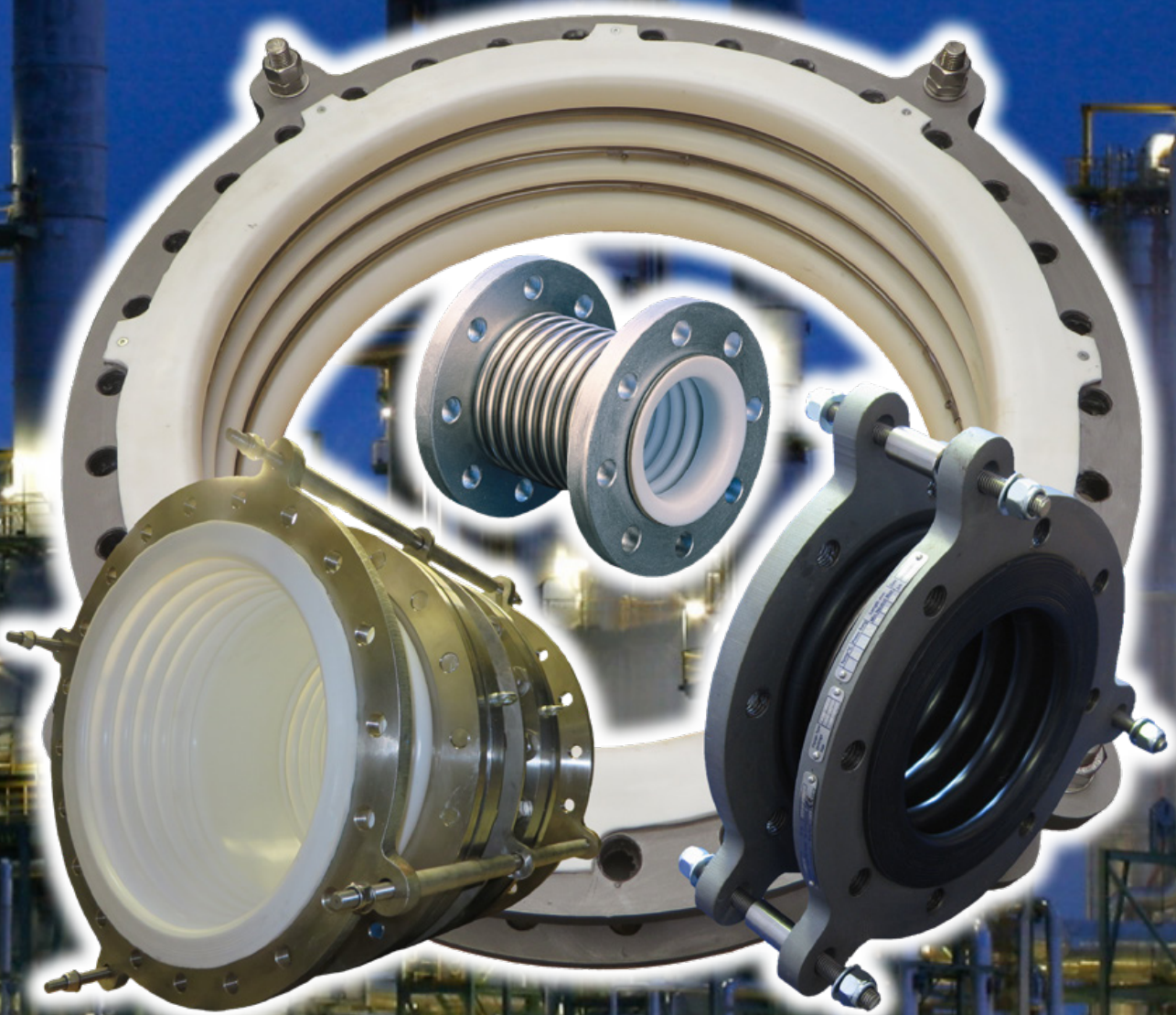

the corrosion expert

FluoroFlow High Performance PTFE Bellows



www.crp.co.uk
www.ptfebellows.com

Corrosion Resistant Products

CRP has been designing, processing and manufacturing top quality paste extruded PTFE and PFA lined products for more than 35 years. All of our products originate from our manufacturing site near Manchester, UK. Using qualified materials, robust and repeatable manufacturing process technologies and a depth of experience CRP are able to deliver product for the most exacting applications.

Introduction

The FluoroFlow Bellows (FFB) range has been engineered over 40 years to compensate for thermal expansion in pipelines; for the protection of fragile process equipment such as graphite, plastic or glass and the isolation of vibration hazards. PTFE bellows come into their own for corrosive, high purity or hot applications.

CRP has some unique manufacturing processes based upon the use of paste extruded PTFE, and a proprietary convolution process. These have been independently tested by the internationally recognised safety and quality group TÜV, undertaking innovative long term pressure increase testing.

The Product Family

The bellows product range covers 22 sizes from DN25 / 1"NB to DN1050 / 42"NB. They are manufactured in two materials—virgin PTFE and static dissipating PTFE. FluoroFlow Bellows in sizes DN25 / 1" to DN250 / 10" are available in extra heavy duty only. For larger diameters there is a choice of two wall thicknesses—a heavy duty (HD) and extra heavy duty (XHD). The bellows can be manufactured with 2 to 10 convolutions. However, this is just the standard product. The flexibility of the manufacturing method is such that many special configurations can be produced to meet specific customer requirements.

For products requiring a higher pressure rating than is possible with PTFE alone, we have our range of armoured bellows (FFAB) where the PTFE is surrounded by a high pressure stainless steel shell.

HiPerFlon®

HiPerFlon® is a second generation paste extruded High Performance PTFE. HiPerFlon® has the

greatest mechanical properties and lowest permeation rates of PTFE materials and as such provides high pressure ratings, long lifetime, low maintenance costs and consequently the lowest cost of ownership.

The Manufacturing Process

CRP uses virgin paste extruded or virgin multi-ply PTFE tubes of their own manufacture to guarantee the highest quality from the beginning of the production process. A unique convolution process undertaken at very high temperatures, combined with additional material to compensate for the extra length from straight to convoluted, provides a uniform PTFE wall thickness and a stress-free material in a thermally locked bellows shape. This process has a significant influence on product lifetime performance.

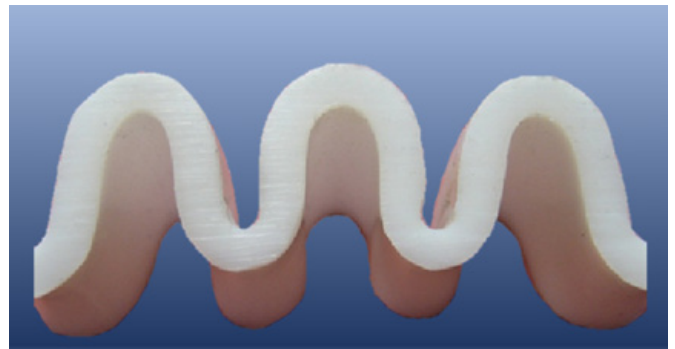

Bellows Design and Type Testing

A key consideration in bellows performance is the temperature and pressure that the bellows will withstand for extended periods of time. There are no ASME, DIN or other global standards for bellows design. Most of CRP's competitors just use a simple burst pressure test at ambient temperature to create the comprehensive pressure / temperature curves in their catalogues, sometimes with a safety factor of less than 3.

A safety factor is defined as the ratio of burst pressure to allowable operating pressure. Bursting pressure tests, although a key indicator, cannot fully define a bellows performance as a burst pressure test has a duration of 10 to 20 seconds and is unable to replicate the effect of deformation of the bellows through creep.

Therefore CRP has developed a much more comprehensive approach to testing as follows:

Bursting Pressure Test

Bursting pressure tests are used only for the determination of pressure rating at ambient (20°C) temperature. At this temperature CRP has adopted a safety factor of 6 for bellows up to DN200 and a safety factor of 4 for the larger diameters.

Pressure Increase Test

In addition to the bursting pressure tests, innovative pressure increase tests have been undertaken successfully at 100°C, 150°C and 200°C by TÜV. These unforgiving tests slowly increase the delivered pressure to the bellows at high temperatures, encouraging the PTFE material to flow and creep as in service. The pressure increase test results confirm the outstanding creep resistance of the FluoroFlow Bellows provided by the unique convolution process.

Internal Pressure Long Term Creep Test

FluoroFlow Bellows have passed successfully an Internal Pressure Creep Test (similar to EN ISO 9080) by TÜV at 150°C. 14 Bellows have been tested in total and two bellows remained under pressure at 150°C in the oven for one year. This confirms the long term creep resistance even at high temperatures and pressures.

Lifetime Assurance

Based on the pressure / temperature limits from these tests, CRP has determined the pressure / temperature curves for the FluoroFlow Bellows to have a residual safety factor of 2 after more than 10 years in operation.

International Standards

All bellows, comply with the Pressure Equipment Directive 2014/68/EU (PED) and the Pressure Equipment (Safety) regulations 2016 (PE(S)R), they are CE / UKCA marked where appropriate, and are provided with CE / UKCA Declaration of conformity. PTFE armoured bellows for high pressure performance are designed according to the Expansion Joint Manufacturers Association (EJMA) international standard. The business is third party accredited to ISO9001:2015.

Product Testing

Bellows materials are fully traceable. Bellows tubes undergo mechanical and dimensional tests following manufacture. PTFE sintering and convoluting are undertaken using calibrated ovens with precise temperature control. Independent process checks are undertaken using infra-red thermometry. In-process visual inspection of the PTFE tubes is undertaken and this combined with a hydrostatic test and further visual inspection of the finished product completes the product verification. Certification is available if required to reassure the customer on materials of construction, process control and product testing.

Operating Temperatures

The standard operating envelope for the product is 0°C to 200°C, but with selection of different flange materials the bellows can be supplied for temperatures outside this envelope.

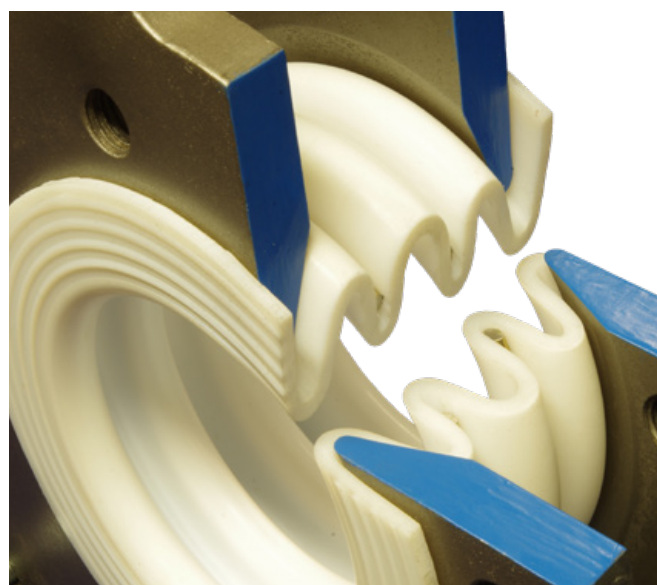

Special Bellows

Many customized bellows are available, including bellows with extended flares, reducing bellows (different flange sizes), different flange types, hinged bellows, lateral bellows, dual containment bellows, bellows with special neutral lengths and bellows with special PTFE wall thicknesses.

Internal vacuum support rings can be provided in exotic metals or PTFE lined and the bellows flanges can be manufactured in other metals. Bellows with electrically isolating tie rods are also available.

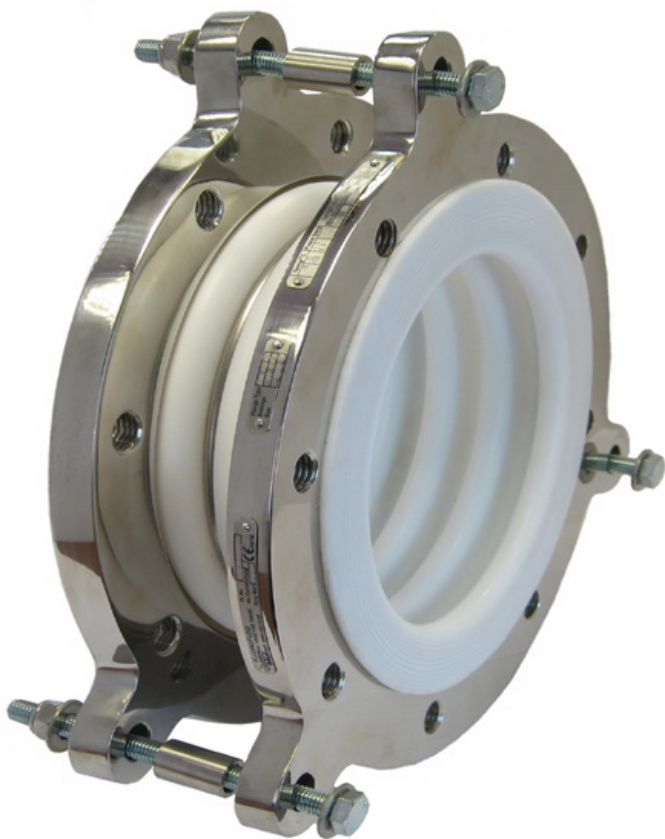

PTFE Bellows with stainless steel flanges

Safety Shields

Following guidance from the European Pressure Equipment Directive 2014/68/EU and international insurers, we strongly recommend the use of Safety Shields around each bellows.

Because of its nature, the bellows is the weakest part of a piping system and safety shields can assist in mitigating risk to operators and the environment.

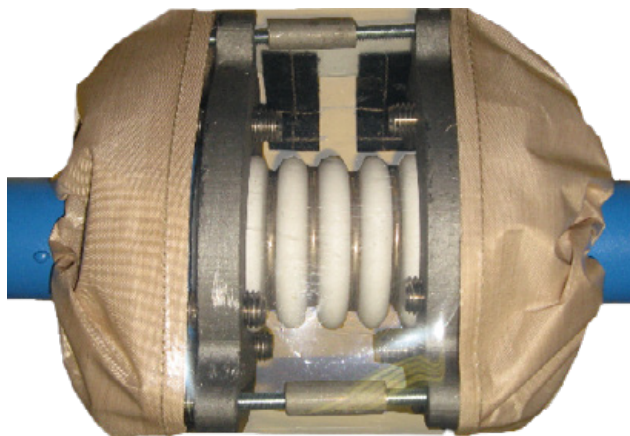

Glassfibre Coated PTFE shield with FEP Window

Smoothbore Sleeves

If handling media at high velocities or with entrained solids we suggest you consider using smoothbore sleeves. These are manufactured from PTFE and provide additional protection to the bellows for abrasive duties as well as minimising the potential build up of solids in the convolutions. As standard these are supplied as a loose fit to avoid the sleeve constraining the bellows movement. However a tight fit is also available. As standard the sleeve is sized to protrude just beyond the end of the bellows when it is at maximum axial length, but this can be specified at the time of order. Anti-static smooth bore sleeves are also available.



Design and Piping Layout

Prior to specifying the bellows it is necessary to produce a piping layout with correct pipe supports and an exact specification of the expected movements, irrespective of whether they are to be used for thermal compensation or the protection of fragile equipment made of glass or graphite. Bellows cannot support forces either from the weight of the piping components or from the liquid inside the pipes.

Effective Area and Spring Rates

The effective area and the spring rates have a significant influence upon the stress calculations for the piping system. Please find the relevant data on the following pages for each bellows size. For the influence of temperature upon spring rates please use the conversion table on the next page.

Temperature Correction Factors (TCF)		
°C	°F	TCF
20°	68°	1.00
80°	176°	0.65
120°	248°	0.50
150°	302°	0.40
200°	404°	0.30

For example: To calculate the spring rate @ 120°C take the spring rate @20° and multiply by 0.5.

Operating and Installation Instructions

A comprehensive user manual is packed with the bellows shipment. These instructions can also be downloaded from our website (www.crp.co.uk) or can be sent out by email (enquiry@crp.co.uk). It is critical that these are referred to for the correct installation of bellows.

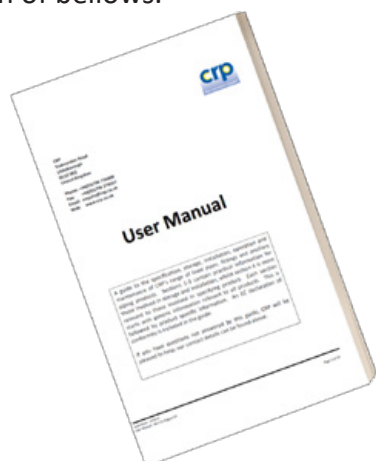

Key Product Features

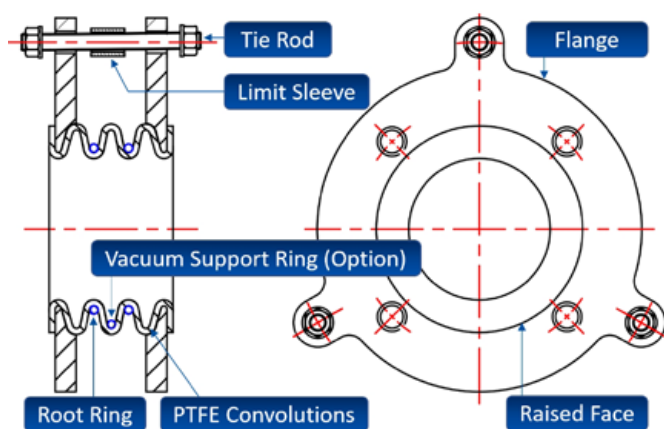

Flanges

Bellows flanges are available to all of the international flange standards including ASME Class

150 and 300 and DIN PN 10 and 16. As standard the flange bolt holes are drilled and tapped either UNC for ASME or Metric Series for DIN. Flanges are painted in an ultra high temperature paint in a silver finish. It is worth noting the internal flange profiling that assists the first convolution in minimising any stress generated by the flange.

PTFE Convolutions

The number of convolutions is key to the range of movement provided by the bellows — the more convolutions the greater the range of movement. However the compromise is that both pressure and vacuum performance are reduced as the number of convolutions increases.

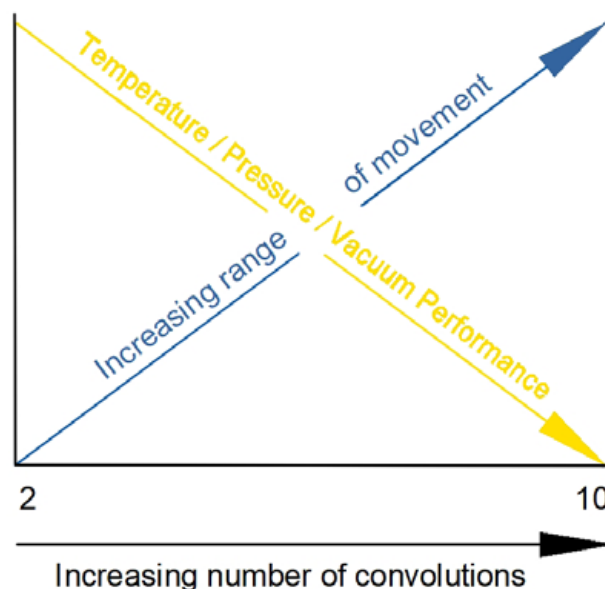

In sizes above DN250 / 10"NB there is the option of Heavy Duty (HD) or Extra Heavy Duty (XHD) Bellows. The additional wall thickness of the XHD product provides an improved temperature and pressure range. Up to DN250 / 10"NB XHD is the standard liner we produce bellows from.

The number of convolutions is key to the range of movement provided by the bellows—the more convolutions the greater the range of movement. However the compromise is that both pressure and vacuum performance are reduced as the number of convolutions.

Root Rings

Root rings serve to provide support for the PTFE which is a mechanically weak material especially when hot. These sit at the base of each convolution.

These are supplied in stainless steel as standard, but can be manufactured in exotic metals where required—for example to avoid the potential for stress corrosion cracking in hydrochloric acid service.

Tie Rods

These prevent the bellows from exceeding their maximum allowed movements. They arrive factory set at the maximum allowable extension as detailed on the data label. The tie rods have been sized to cope with the maximum pressure thrust that can result from internal pressure in the bellows, both in operation and during test. However, tie rods are not designed to cope with external loads applied to the bellows by the adjacent pipe work due to circumstances such as pipework misalignment, failure of anchors etc.

Limit Sleeves

These prevent damage to the convolutions by preventing the bellows from being compressed below the minimum allowable axial length.

Anti-Snake Rings

When the number of convolutions exceeds five we would recommend one or more Anti-snake rings. These are mounted on the outside of the bellows, replacing and serving the role of the root ring, but also tying into the tie rod to prevent the bellows squirming under high temperatures and pressures.



Vacuum Support Rings

Internal vacuum support rings are available for larger bellows where they have a low or no vacuum performance. They will enable the bellows to perform under full vacuum. These rings fit inside the bellows convolutions, so are exposed to the process. They are available either PTFE encapsulated on the outside, or in various exotic metals. They may reduce bellows movements, so please consult with us.

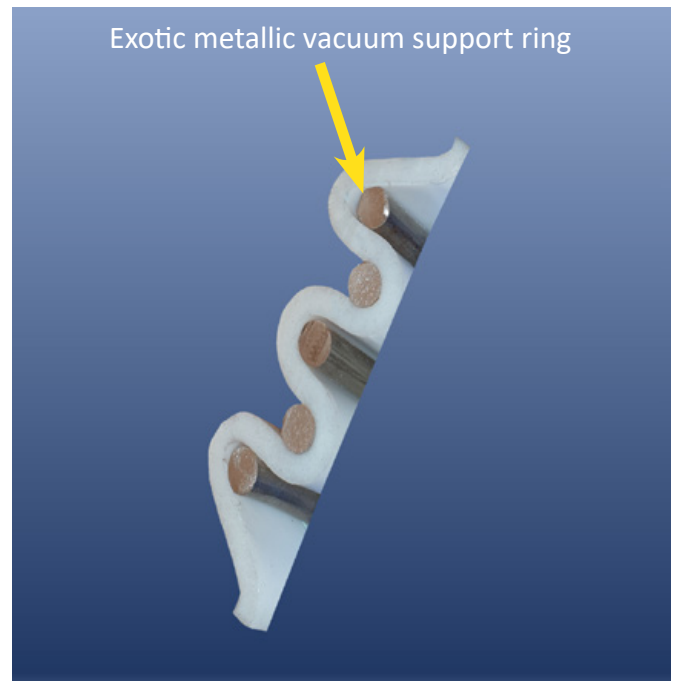

Data Labels

There are three or four data labels riveted to the bellows flanges to carry as much information about the bellows as practical.

However, more information is available in this catalogue, or by reference to CRP, quoting the part number and serial number references.



Identification Nameplate

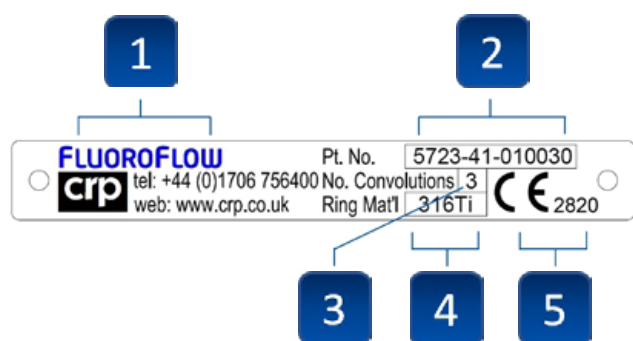

1. The product family is referred to as FluoroFlow Bellows or “FFB”.
2. The CRP part number.
3. The number of convolutions.
4. The material used for the root rings.
5. Our CE mark and notified body number for compliance with the PED (Pressure Equipment Directive).

Flange Drillings Nameplate

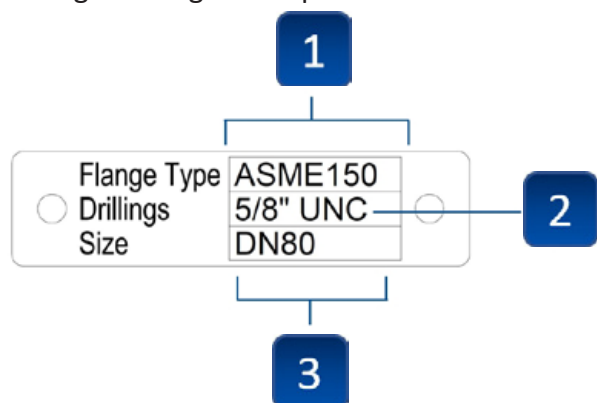

If the flanges are identical there will be one of these labels. However should the flanges be dissimilar, there will be a label on each flange.

1. The flange type.
2. The size and thread type for the drillings.
3. The bellows nominal size or in the case of reducing bellows, the flange size at each end.

Operating Parameters Nameplate

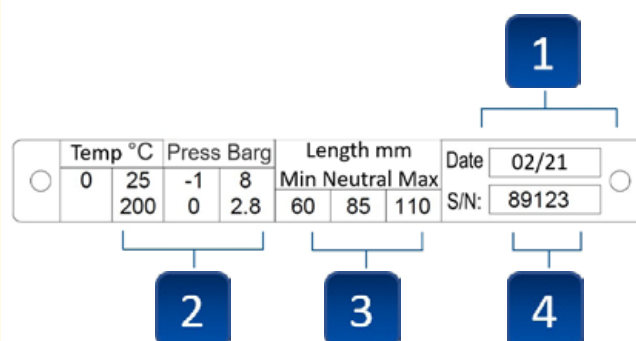

1. The month and year of manufacture.
2. Two rows of temperature and pressure information. In this example showing the performance at 0°C to 25°C (-1 up to 8 Barg) and 200°C (0 up to 2.8 Barg). There is not always enough room to show the maximum temperature which can cope with full vacuum, nor provide intermediate data. Reference to the data sheets in this catalogue can provide more information.
3. The minimum, neutral and maximum lengths for axial travel.
4. A unique serial number for the item.

Explanation of Movements

A key attribute of bellows is their ability to move in response to stresses placed upon them by the equipment to which they are mounted, whether such stresses are generated by expansion and contraction or plant vibration.

There are three directions of movement for which a bellows is designed; axial, lateral and angular. Please note that bellows are not designed for rotational movement around the principal axis.

The allowable movements are dependent upon nominal bore and number of convolutions and are provided on the following individual product nominal bore pages. It is important to understand that these movements are not independent.

Combined Movements

When calculating maximum combined movements consider the total allowable in all three directions as comprising 100%. This 100% can be apportioned across the three movement

types. For instance if a bellows were installed at an axial length utilising 50% of the allowable axial movement of the bellows and there were no angular movement, only 50% of the published lateral movement would be remaining within the safe movement limits with these concurrent movements. If 25% of the maximum allowable angular movement was utilised concurrently with 50% of the axial movement then only 25% of the lateral movement would be remaining.

Axial

This is the most frequently required type of movement and is specified in terms of the bellows minimum and maximum extension and its neutral length. The neutral length is the mid-range position of the bellows. Bellows can be installed at lengths between the minimum and maximum length, but this of course will restrict the amount of allowable movement. CRP Bellows do not require restraining to hold their neutral length and are delivered with the flanges sitting at their neutral length with the tie rods set to their maximum extension.

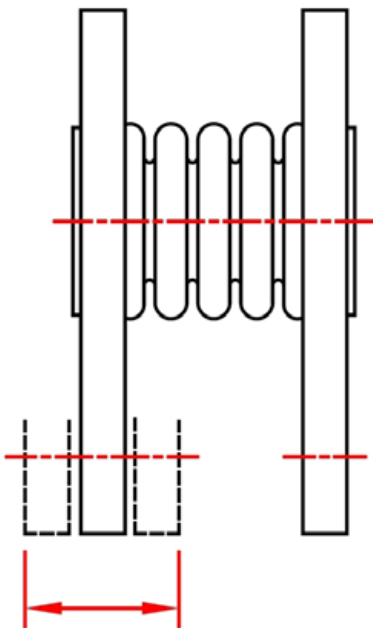

Axial Only Bellows

Lateral

Lateral movement is movement at right angles to the principal axis.

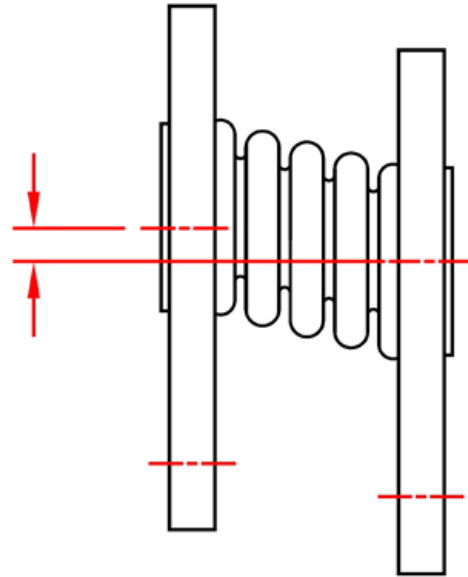

Angular

Angular movement is the movement of the flanges out of parallel.

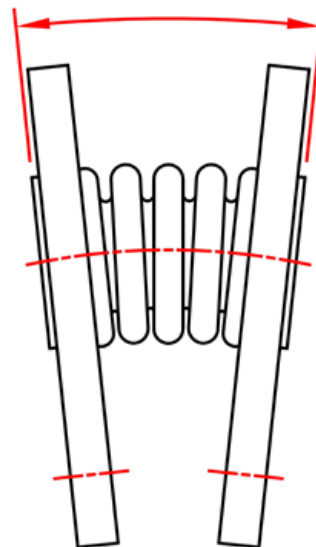

Modified Movement Bellows

The mechanical design of the flanges, tie rods and limit sleeves are to restrict bellows movement within their safe range. However, it may be necessary to change movement still further, such as preventing movement in one or more planes, focus all movement in one plane or create additional movement. Special bellows are available for these purposes.

Axial Only Bellows [Axial Bellows]

By providing an external frame with guide rods, the bellows can be restricted to axial movement only.

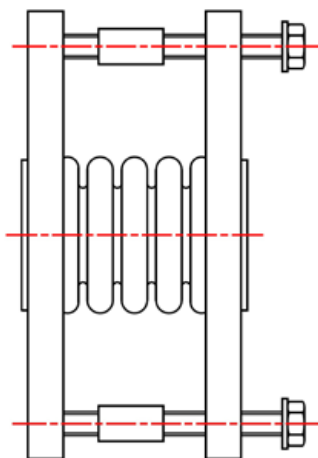

Movement	Possible
Axial	✓
Lateral	no
Angular	no

Lateral Only Bellows [Lateral Bellows]

Tie rods with special spherical washers capturing the flange face allow movement in any lateral plane.

Movement	Possible
Axial	no
Lateral (any plane)	✓
Angular	no

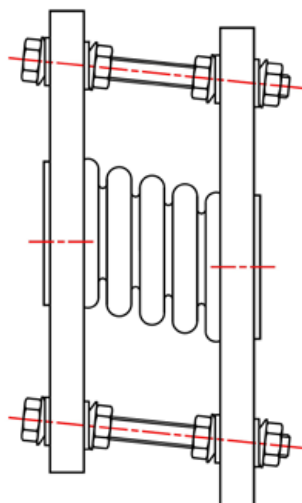

One Plane Angular Bellows [Hinged Bellows]

Hinged bellows allow angular movement only in one plane, thereby maximising the angular range.

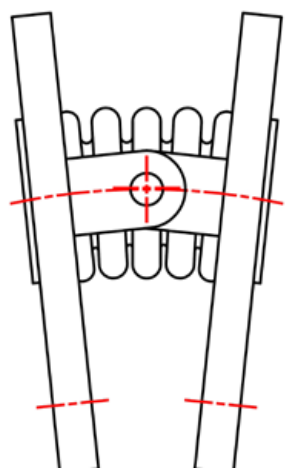

Movement	Possible
Axial	no
Lateral	no
Angular (one plane)	✓

All Planes Angular Bellows [Gimballed Bellows]

As with the hinged bellows they allow only angular movements, but with the addition of gimbals enables angular movement in any plane.

Movement	Possible
Axial	no
Lateral	no
Angular (any plane)	✓

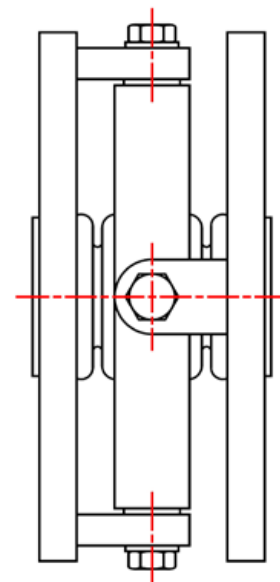

Large Movement Lateral Bellows [Universal Bellows]

An arrangement of two bellows incorporating a short PTFE lined pipe spool provides a large amount of lateral movement by effectively converting each bellows into an angular bellows.

Movement	Possible
Axial	✓
Large Lateral	✓
Angular	✓

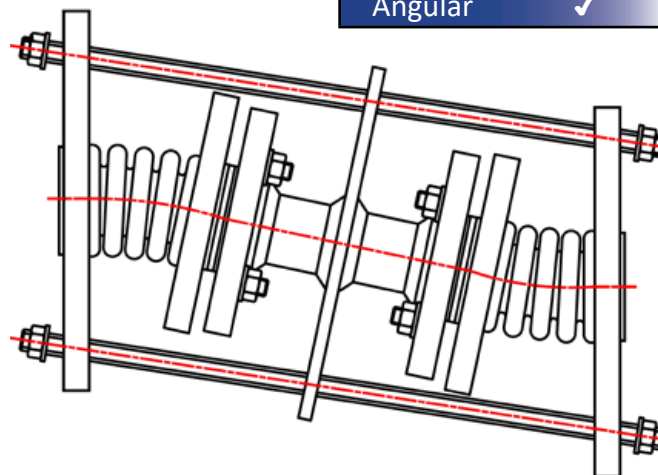

FluoroFlow FFB PTFE Bellows are manufactured from virgin or static dissipating paste extruded HiPerFlon® PTFE. They are manufactured using a unique process which ensures a uniform PTFE wall thickness and eliminates stress in the PTFE from the convolution process. These bellows have an Extra Heavy Duty "XHD" liner.

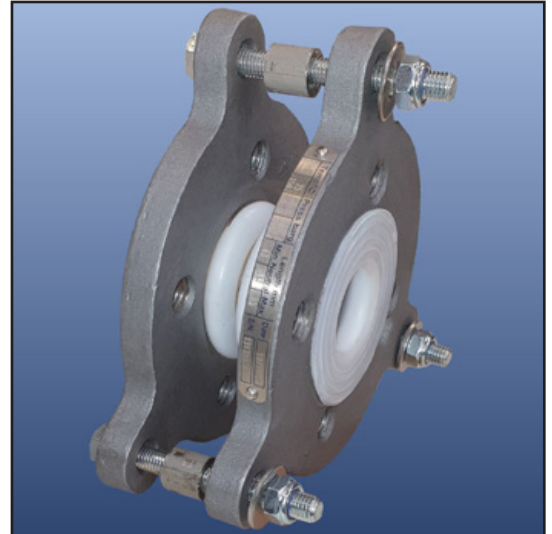
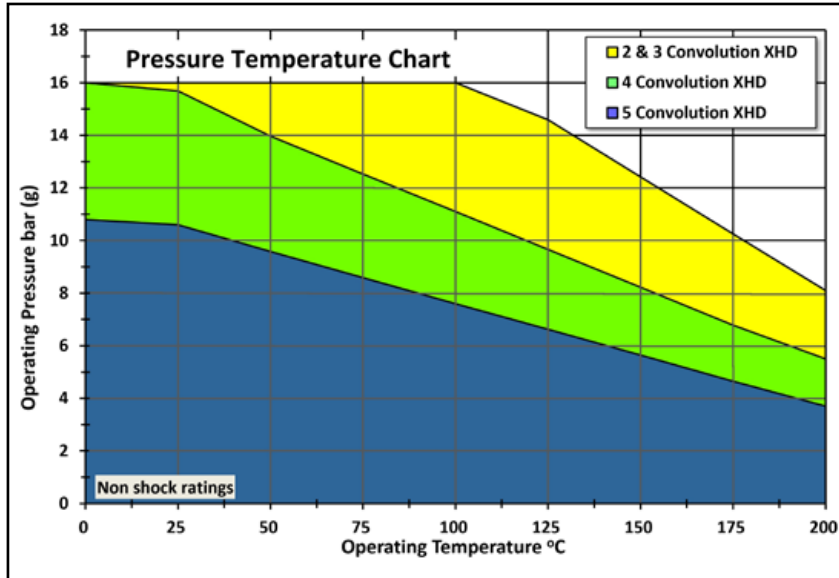

Images are illustrative only, actual bellows may differ.

Dimensions and Movements ¹						Weight
Convolutions ⁴	Neutral Length [mm]	Minimum Length [mm]	Maximum Length [mm]	Lateral +/- [mm]	Angular +/- [degrees]	[kg]
FFB 2	43	36	50	4	6	2
FFB 3	54	43	65	6	10	2
FFB 4	65	50	80	8	13	2
FFB 5	76	57	95	10	17	2

Spring Rates ² @ 20°C +/- 50%			
Axial Compression [N/mm]	Axial Extension [N/mm]	Lateral [N/mm]	Angular [Nm/°]
242	80	69	0.5
161	53	46	0.3
121	40	35	0.2
97	32	28	0.2

Materials	
Component	Materials
Bellows	Paste Extruded Virgin PTFE to ASTM D4895
Flanges	Carbon Steel to BS1501-161-430A / P265GH Typical
Paint	Ultra-High Temperature in Silver
Root Rings	Stainless Steel to 320S31 (316Ti)
Tie Rods & Nuts	Carbon Steel Grade 8.8 Zinc Plated
Limit Sleeves	Stainless Steel to ASTM A312 Gr. 304/304L

Flanges		
	ASME Class 150	DIN PN10/16
Raised Face Ø	51mm	68mm
Bolt Circle Ø	79mm	85mm
Flange Ø max	167mm	
Bolt Holes ³ [No x Thread]	4 x 1/2" UNC	4 X M12
Thickness	12mm	
Effective Area	1,000mm ²	

Options	
Component	Options
Bellows	Paste Extruded Static-Dissipating ASTM D4895
Flanges	Stainless Steel, Hastelloy, Low Temperature Steels etc.
Root Rings	Hastelloy, Monel etc.
Tie Rods & Nuts	Stainless Steel, Hastelloy, Monel etc.
Anti-Snake Rings	Stainless Steel

Vacuum Performance Bar(g)				
Model	20°C	100°C	150°C	200°C
FFB 2 XHD	-1.0	-1.0	-1.0	-1.0
FFB 3 XHD	-1.0	-1.0	-1.0	-1.0
FFB 4 XHD	-1.0	-1.0	-1.0	-1.0
FFB 5 XHD	-1.0	-1.0	-1.0	-1.0

- Notes:
1. Larger movements are available with more convolutions if required. These are not combined movements please refer to page 7.
 2. Please refer to page 5 for temperature correction factors for spring rate.
 3. As standard flange holes are threaded. Clearance holes are possible for certain sizes please contact us.
 4. The maximum number of convolutions for this size is 10, please consult us for further information on these.
 5. For operating temperature and pressure for more than 5 convolutions please contact us.

FluoroFlow FFB PTFE Bellows are manufactured from virgin or static dissipating paste extruded HiPerFlon® PTFE. They are manufactured using a unique process which ensures a uniform PTFE wall thickness and eliminates stress in the PTFE from the convolution process. These bellows have an Extra Heavy Duty “XHD” liner.

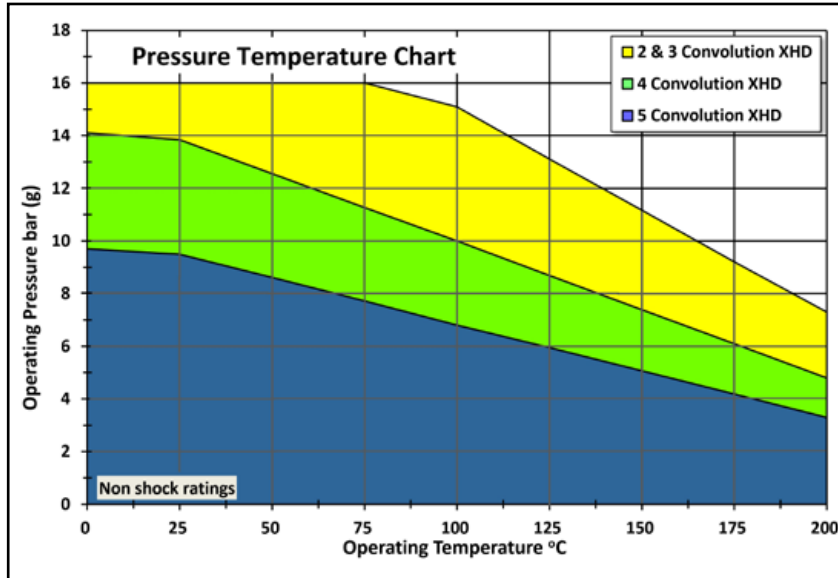

Dimensions and Movements ¹						Weight
Convolutions ⁴	Neutral Length [mm]	Minimum Length [mm]	Maximum Length [mm]	Lateral +/- [mm]	Angular +/- [degrees]	[kg]
FFB 2	54	46	62	4	6	4
FFB 3	69	56	82	6	10	4
FFB 4	84	66	102	8	13	4
FFB 5	99	76	122	12	17	4

Spring Rates ² @ 20°C +/- 50%			
Axial Compression [N/mm]	Axial Extension [N/mm]	Lateral [N/mm]	Angular [Nm/°]
330	116	135	1.4
220	77	90	0.9
165	58	68	0.7
132	46	54	0.5

Materials	
Component	Materials
Bellows	Paste Extruded Virgin PTFE to ASTM D4895
Flanges	Carbon Steel to BS1501-161-430A / P265GH Typical
Paint	Ultra-High Temperature in Silver
Root Rings	Stainless Steel to 320S31 (316Ti)
Tie Rods & Nuts	Carbon Steel Grade 8.8 Zinc Plated
Limit Sleeves	Stainless steel to ASTM A312 Gr. 304/304L

Flanges ⁶	
	DIN PN10/16
Raised Face Ø	78mm
Bolt Circle Ø	100mm
Flange Ø max	204mm
Bolt Holes ³ [No x Thread]	4 x M16
Thickness	16mm
Effective Area	2,200mm ²

Options	
Component	Options
Bellows	Paste Extruded Static-Dissipating ASTM D4895
Flanges	Stainless Steel, Hastelloy, Low Temperature Steels etc.
Root Rings	Hastelloy, Monel etc.
Tie Rods & Nuts	Stainless steel, Hastelloy, Monel etc.
Anti-Snake Rings	Stainless Steel

Vacuum Performance Bar(g)				
Model	20°C	100°C	150°C	200°C
FFB 2 XHD	-1.0	-1.0	-1.0	-1.0
FFB 3 XHD	-1.0	-1.0	-1.0	-1.0
FFB 4 XHD	-1.0	-1.0	-1.0	-1.0
FFB 5 XHD	-1.0	-1.0	-1.0	-1.0

Notes:

- Larger movements are available with more convolutions. These are not combined movements, please refer to page 7 for info.
- Please refer to page 5 for temperature correction factors for spring rate.
- As standard flange holes are threaded. Clearance holes are possible for certain sizes please contact us.
- The maximum number of convolutions for this size is 10, please consult us for further information on these.
- For operating temperature and pressure for more than 5 convolutions please contact us.
- Size 1.1/4" class 150 FFB bellows are also available with ASME 150 flanges & have the same dimensions as the 1" FFB.

FluoroFlow FFB PTFE Bellows are manufactured from virgin or static dissipating paste extruded HiPerFlon® PTFE. They are manufactured using a unique process which ensures a uniform PTFE wall thickness and eliminates stress in the PTFE from the convolution process. These bellows have an Extra Heavy Duty "XHD" liner.

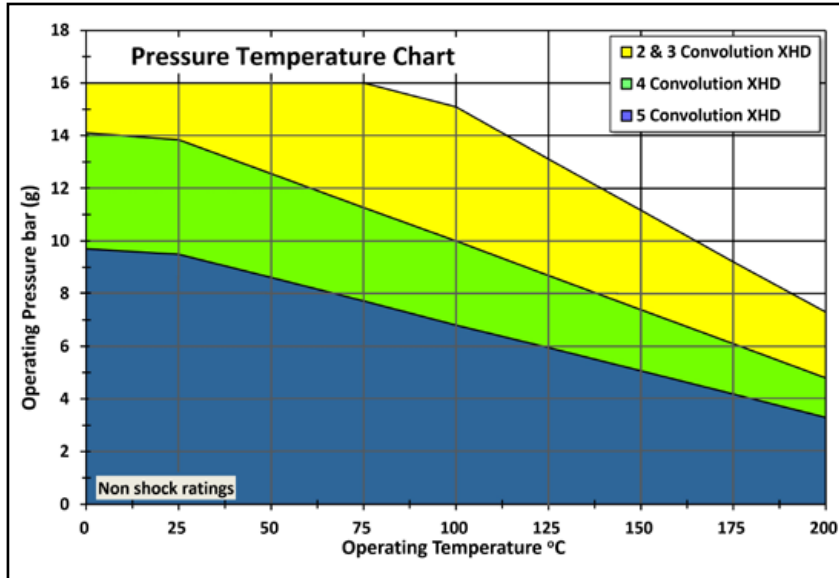

Dimensions and Movements ¹						Weight
Convolutions ⁴	Neutral Length [mm]	Minimum Length [mm]	Maximum Length [mm]	Lateral +/- [mm]	Angular +/- [degrees]	[kg]
FFB 2	54	46	62	4	6	5
FFB 3	69	56	82	6	10	5
FFB 4	84	66	102	8	13	5
FFB 5	99	76	122	12	17	5

Spring Rates ² @ 20°C +/- 50%			
Axial Compression [N/mm]	Axial Extension [N/mm]	Lateral [N/mm]	Angular [Nm/°]
330	116	135	1.4
220	77	90	0.9
165	58	68	0.7
132	46	54	0.5

Materials	
Component	Materials
Bellows	Paste Extruded Virgin PTFE to ASTM D4895
Flanges	Carbon Steel to BS1501-161-430A / P265GH Typical
Paint	Ultra-High Temperature in Silver
Root Rings	Stainless Steel to 320S31 (316Ti)
Tie Rods & Nuts	Carbon Steel Grade 8.8 Zinc Plated
Limit Sleeves	Stainless Steel to ASTM A312 Gr. 304/304L

Flanges		
	ASME Class 150	DIN PN10/16
Raised Face Ø	73mm	88mm
Bolt Circle Ø	98mm	110mm
Flange Ø max	204mm	
Bolt Holes ³ [No x Thread]	4 x 1/2"UNC	4 x M16
Thickness	16	
Effective Area	2,200mm ²	

Options	
Bellows ⁶	Paste Extruded Static-Dissipating ASTM D4895
Flanges	Stainless Steel, Hastelloy, Low Temperature Steels etc.
Root Rings	Hastelloy, Monel etc.
Tie Rods & Nuts	Stainless Steel, Hastelloy, Monel etc.
Anti-Snake Rings	Stainless Steel

Vacuum Performance bar(g)				
Model	20°C	100°C	150°C	200°C
FFB 2 XHD	-1.0	-1.0	-1.0	-1.0
FFB 3 XHD	-1.0	-1.0	-1.0	-1.0
FFB 4 XHD	-1.0	-1.0	-1.0	-1.0
FFB 5 XHD	-1.0	-1.0	-1.0	-1.0

- Notes:
- Larger movements are available with more convolutions. These are not combined movements, please refer to page 7 for info.
 - Please refer to page 5 for temperature correction factors for spring rate.
 - As standard flange holes are threaded. Clearance holes are possible for certain sizes please contact us.
 - The maximum number of convolutions for this size is 10, please consult us for further information on these.
 - For operating temperature and pressure for more than 5 convolutions please contact us.

FluoroFlow FFB PTFE Bellows are manufactured from virgin or static dissipating paste extruded HiPerFlon® PTFE. They are manufactured using a unique process which ensures a uniform PTFE wall thickness and eliminates stress in the PTFE from the convolution process. These bellows have an Extra Heavy Duty "XHD" liner.

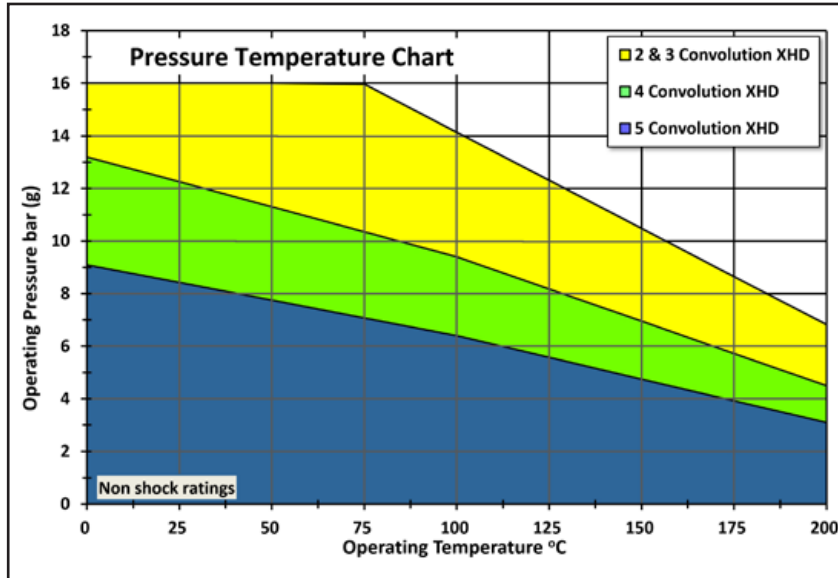

Dimensions and Movements ¹						Weight
Convolutions ⁴	Neutral Length [mm]	Minimum Length [mm]	Maximum Length [mm]	Lateral +/- [mm]	Angular +/- [degrees]	[kg]
FFB 2	55	44	66	6	7	5
FFB 3	70	54	86	9	11	5
FFB 4	85	64	106	12	14	5
FFB 5	100	74	126	15	18	6

Spring Rates ² @ 20°C +/- 50%			
Axial Compression [N/mm]	Axial Extension [N/mm]	Lateral [N/mm]	Angular [Nm/°]
396	135	285	2.4
264	90	190	1.6
198	68	143	1.2
158	54	114	0.9

Materials	
Component	Materials
Bellows	Paste Extruded Virgin PTFE to ASTM D4895
Flanges	Carbon Steel to BS1501-161-430A / P265GH Typical
Paint	Ultra-High Temperature in Silver
Root Rings	Stainless Steel to 320S31 (316Ti)
Tie Rods & Nuts	Carbon Steel Grade 8.8 Zinc Plated
Limit Sleeves	Stainless steel to ASTM A312 Gr. 304/304L

Flanges		
	ASME Class 150	DIN PN10/16
Raised Face Ø	92mm	102mm
Bolt Circle Ø	121mm	125mm
Flange Ø max	220mm	
Bolt Holes ³ [No x Thread]	4 x 5/8"UNC	4 x M16
Thickness	16mm	
Effective Area	3,200mm ²	

Options	
Component	Options
Bellows	Paste Extruded Static-Dissipating ASTM D4895
Flanges	Stainless Steel, Hastelloy, Low Temperature Steels etc.
Root Rings	Hastelloy, Monel etc.
Tie Rods & Nuts	Stainless steel, Hastelloy, Monel etc.
Anti-Snake Rings	Stainless Steel

Vacuum Performance bar(g)				
Model	20°C	100°C	150°C	200°C
FFB 2 XHD	-1.0	-1.0	-1.0	-1.0
FFB 3 XHD	-1.0	-1.0	-1.0	-1.0
FFB 4 XHD	-1.0	-1.0	-1.0	-1.0
FFB 5 XHD	-1.0	-1.0	-1.0	-1.0

Notes:

1. Larger movements are available with more convolutions. These are not combined movements, please refer to page 7 for info.
2. Please refer to page 5 for temperature correction factors for spring rate.
3. As standard flange holes are threaded. Clearance holes are possible for certain sizes please contact us.
4. The maximum number of convolutions for this size is 10, please consult us for further information on these.
5. For operating temperature and pressure for more than 5 convolutions please contact us.

FluoroFlow FFB PTFE Bellows are manufactured from virgin or static dissipating paste extruded HiPerFlon® PTFE. They are manufactured using a unique process which ensures a uniform PTFE wall thickness and eliminates stress in the PTFE from the convolution process. These bellows have an Extra Heavy Duty "XHD" liner.

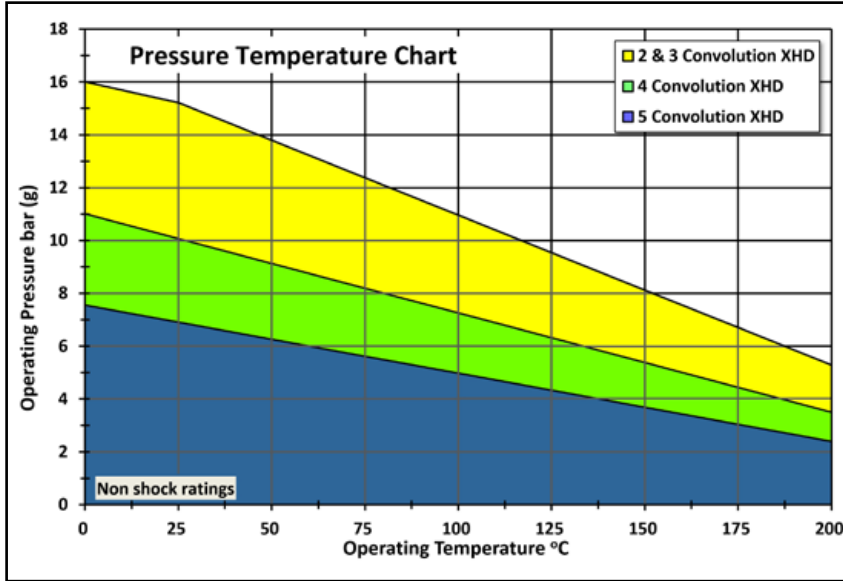

Dimensions and Movements ¹						Weight
Convolutions ⁴	Neutral Length [mm]	Minimum Length [mm]	Maximum Length [mm]	Lateral +/- [mm]	Angular +/- [degrees]	[kg]
FFB 2	65	54	76	6	7	6
FFB 3	85	69	101	9	10	6
FFB 4	105	84	126	12	13	7
FFB 5	125	99	151	15	16	7

Spring Rates ² @ 20°C +/- 50%			
Axial Compression [N/mm]	Axial Extension [N/mm]	Lateral [N/mm]	Angular [Nm/°]
420	134	245	4.0
280	89	163	2.7
210	67	122	2.0
168	53	98	1.6

Materials	
Component	Materials
Bellows	Paste Extruded Virgin PTFE to ASTM D4895
Flanges	Carbon Steel to BS1501-161-430A / P265GH Typical
Paint	Ultra-High Temperature in Silver
Root Rings	Stainless Steel to 320S31 (316Ti)
Tie Rods & Nuts	Carbon Steel Grade 8.8 Zinc Plated
Limit Sleeves	Stainless Steel to ASTM A312 Gr. 304/304L

Flanges		
	ASME Class 150	DIN PN10/16
Raised Face Ø	105mm	122mm
Bolt Circle Ø	140mm	145mm
Flange Ø max	240mm	
Bolt Holes ³ [No x Thread]	4 x 5/8"UNC	8 x M16
Thickness	16mm	
Effective Area	5,200mm ²	

Options	
Bellows ⁶	Paste Extruded Static-Dissipating ASTM D4895
Flanges	Stainless Steel, Hastelloy, Low Temperature Steels etc.
Root Rings	Hastelloy, Monel etc.
Tie Rods & Nuts	Stainless Steel, Hastelloy, Monel etc.
Anti-Snake Rings	Stainless Steel

Vacuum Performance bar(g)				
Model	20°C	100°C	150°C	200°C
FFB 2 XHD	-1.0	-1.0	-1.0	-1.0
FFB 3 XHD	-1.0	-1.0	-1.0	-1.0
FFB 4 XHD	-1.0	-1.0	-1.0	-1.0
FFB 5 XHD	-1.0	-1.0	-1.0	-1.0

- Notes:
1. Larger movements are available with more convolutions. These are not combined movements, please refer to page 7 for info.
 2. Please refer to page 3 for temperature correction factors for spring rate.
 3. As standard flange holes are threaded. Clearance holes are possible for certain sizes please contact us.
 4. The maximum number of convolutions for this size is 10, please consult us for further information on these.
 5. For operating temperature and pressure for more than 5 convolutions please contact us.

FluoroFlow FFB PTFE Bellows are manufactured from virgin or static dissipating paste extruded HiPerFlon® PTFE. They are manufactured using a unique process which ensures a uniform PTFE wall thickness and eliminates stress in the PTFE from the convolution process. These bellows have an Extra Heavy Duty "XHD" liner.

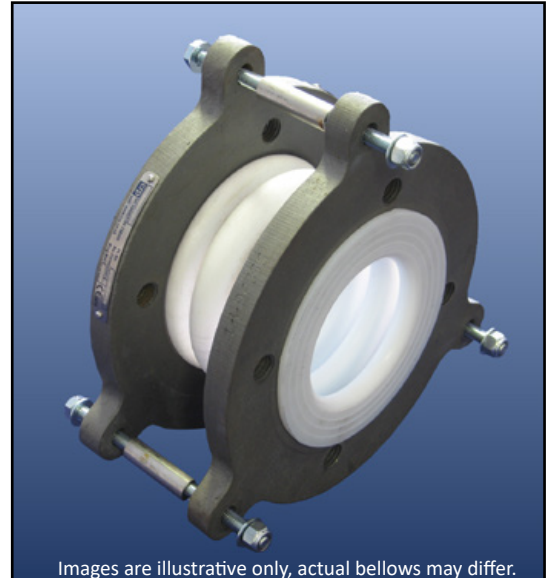
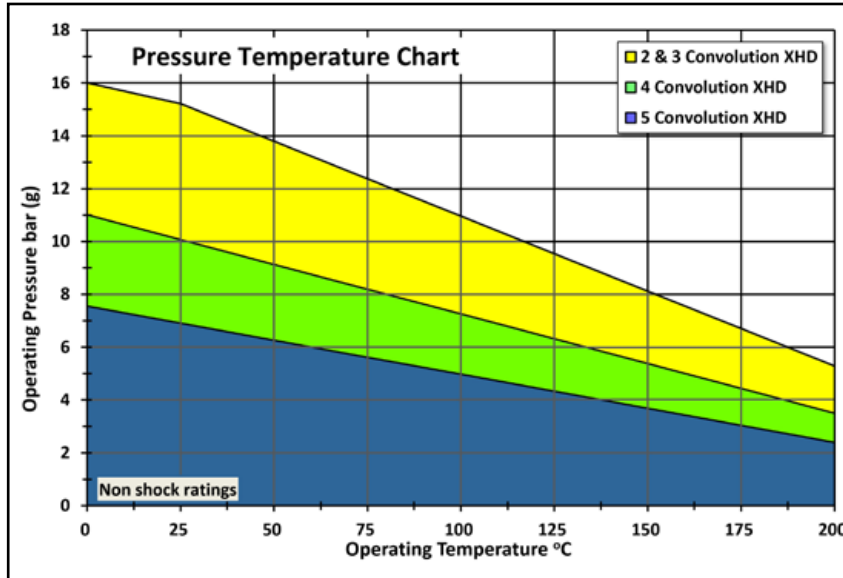

Dimensions and Movements ¹						Weight
Convolutions ⁴	Neutral Length [mm]	Minimum Length [mm]	Maximum Length [mm]	Lateral +/- [mm]	Angular +/- [degrees]	[kg]
FFB 2	65	52	78	7	7	7
FFB 3	85	66	104	11	11	8
FFB 4	105	81	129	15	14	8
FFB 5	125	95	155	19	18	8

Spring Rates ² @ 20°C +/- 50%			
Axial Compression [N/mm]	Axial Extension [N/mm]	Lateral [N/mm]	Angular [Nm/°]
465	129	275	6.0
310	86	183	4.0
233	65	137	3.0
186	52	110	2.4

Materials	
Component	Materials
Bellows	Paste Extruded Virgin PTFE to ASTM D4895
Flanges	Carbon Steel to BS1501-161-430A / P265GH Typical
Paint	Ultra-High Temperature in Silver
Root Rings	Stainless Steel to 320S31 (316Ti)
Tie Rods & Nuts	Carbon Steel Grade 8.8 Zinc Plated
Limit Sleeves	Stainless Steel to ASTM A312 Gr. 304/304L

Flanges		
	ASME Class 150	DIN PN10/16
Raised Face Ø	127mm	138mm
Bolt Circle Ø	152mm	160mm
Flange Ø max	260mm	
Bolt Holes ³ [No x Thread]	4 x 5/8"UNC	8 x M16
Thickness	16mm	
Effective Area	7,300mm ²	

Options	
Bellows ⁶	Paste Extruded Static-Dissipating ASTM D4895
Flanges	Stainless Steel, Hastelloy, Low Temperature Steels etc.
Root Rings	Hastelloy, Monel etc.
Tie Rods & Nuts	Stainless Steel, Hastelloy, Monel etc.
Anti-Snake Rings	Stainless Steel

Vacuum Performance bar(g)				
Model	20°C	100°C	150°C	200°C
FFB 2 XHD	-1.0	-1.0	-1.0	-1.0
FFB 3 XHD	-1.0	-1.0	-1.0	-1.0
FFB 4 XHD	-1.0	-1.0	-1.0	-1.0
FFB 5 XHD	-1.0	-1.0	-1.0	-1.0

Notes:

- Larger movements are available with more convolutions. These are not combined movements, please refer to page 7 for info.
- Please refer to page 3 for temperature correction factors for spring rate.
- As standard flange holes are threaded. Clearance holes are possible for certain sizes please contact us.
- The maximum number of convolutions for this size is 10, please consult us for further information on these.
- For operating temperature and pressure for more than 5 convolutions please contact us.

FluoroFlow FFB PTFE Bellows are manufactured from virgin or static dissipating paste extruded HiPerFlon® PTFE. They are manufactured using a unique process which ensures a uniform PTFE wall thickness and eliminates stress in the PTFE from the convolution process. These bellows have an Extra Heavy Duty "XHD" liner.

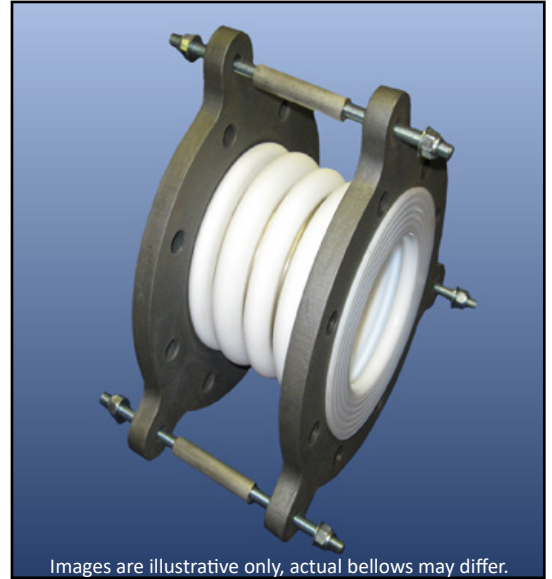
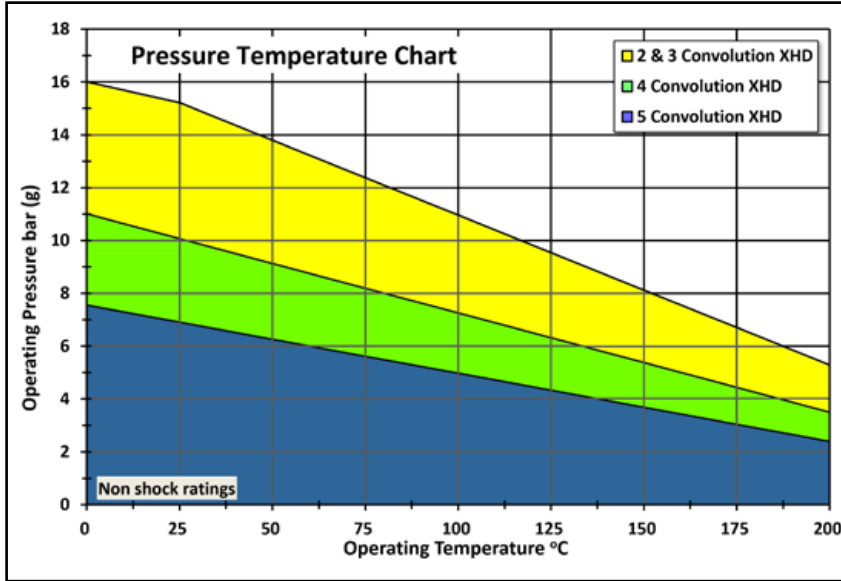

Dimensions and Movements ¹						Weight
Convolutions ⁴	Neutral Length [mm]	Minimum Length [mm]	Maximum Length [mm]	Lateral +/- [mm]	Angular +/- [degrees]	[kg]
FFB 2	67	52	82	8	7	10
FFB 3	91	70	112	12	10	10
FFB 4	115	88	142	16	13	10
FFB 5	139	106	172	20	17	10

Spring Rates ² @ 20°C +/- 50%			
Axial Compression [N/mm]	Axial Extension [N/mm]	Lateral [N/mm]	Angular [Nm/°]
530	191	311	10.2
353	127	207	6.8
265	95	155	5.1
212	76	124	4.1

Materials	
Component	Materials
Bellows	Paste Extruded Virgin PTFE to ASTM D4895
Flanges	Carbon Steel to BS1501-161-430A / P265GH Typical
Paint	Ultra-High Temperature in Silver
Root Rings	Stainless Steel to 320S31 (316Ti)
Tie Rods & Nuts	Carbon Steel Grade 8.8 Zinc Plated
Limit Sleeves	Stainless Steel to ASTM A312 Gr. 304/304L

Flanges		
	ASME Class 150	DIN PN10/16
Raised Face Ø	157mm	158mm
Bolt Circle Ø	191mm	180mm
Flange Ø max	308mm	
Bolt Holes ³ [No x Thread]	8 x 5/8" UNC	8 x M16
Thickness	16mm	
Effective Area	10,200mm ²	

Options	
Component	Options
Bellows	Paste Extruded Static-Dissipating ASTM D4895
Flanges	Stainless Steel, Hastelloy, Low Temperature Steels etc.
Root Rings	Hastelloy, Monel etc.
Tie Rods & Nuts	Stainless Steel, Hastelloy, Monel etc.
Anti-Snake Rings	Stainless Steel

Vacuum Performance bar(g)				
Model	20°C	100°C	150°C	200°C
FFB 2 XHD	-1.0	-1.0	-1.0	-1.0
FFB 3 XHD	-1.0	-1.0	-1.0	-1.0
FFB 4 XHD	-1.0	-1.0	-1.0	-1.0
FFB 5 XHD	-1.0	-1.0	-1.0	-1.0

- Notes:
1. Larger movements are available with more convolutions. These are not combined movements, please refer to page 7 for info.
 2. Please refer to page 3 for temperature correction factors for spring rate.
 3. As standard flange holes are threaded. Clearance holes are possible for certain sizes please contact us.
 4. The maximum number of convolutions for this size is 10, please consult us for further information on these.
 5. For operating temperature and pressure for more than 5 convolutions please contact us.

FluoroFlow FFB PTFE Bellows DN125 / 5"NB

FluoroFlow FFB PTFE Bellows are manufactured from virgin or static dissipating paste extruded HiPerFlon® PTFE. They are manufactured using a unique process which ensures a uniform PTFE wall thickness and eliminates stress in the PTFE from the convolution process. These bellows have an Extra Heavy Duty "XHD" liner.

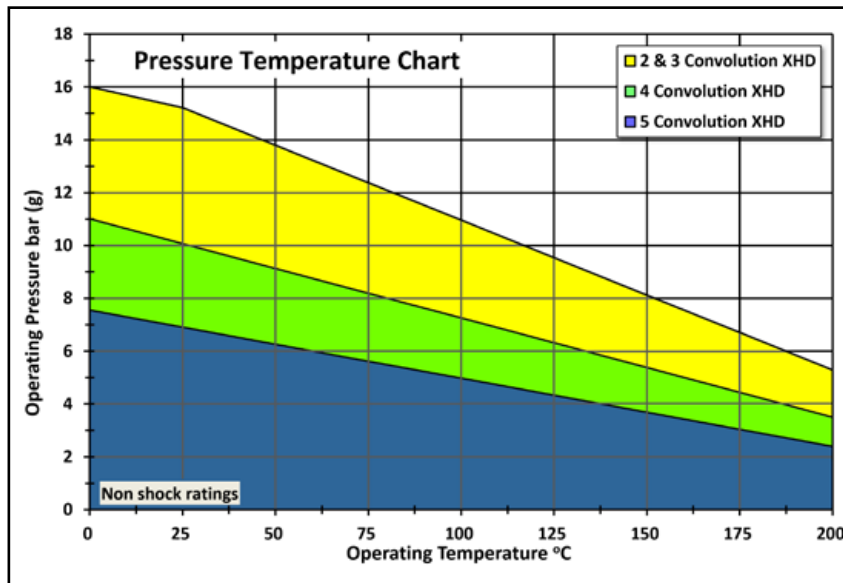

Dimensions and Movements ¹						Weight
Convolutions ⁴	Neutral Length [mm]	Minimum Length [mm]	Maximum Length [mm]	Lateral +/- [mm]	Angular +/- [degrees]	[kg]
FFB 2	75	60	90	8	6	12
FFB 3	103	82	124	12	9	13
FFB 4	131	103	159	16	12	13
FFB 5	159	125	193	20	15	13

Spring Rates ² @ 20°C +/- 50%			
Axial Compression [N/mm]	Axial Extension [N/mm]	Lateral [N/mm]	Angular [Nm/°]
453	225	356	16.3
302	150	237	10.9
227	113	178	8.1
181	90	142	6.5

Materials	
Component	Materials
Bellows	Paste Extruded Virgin PTFE to ASTM D4895
Flanges	Carbon Steel to BS1501-161-430A / P265GH Typical
Paint	Ultra-High Temperature in Silver
Root Rings	Stainless Steel to 320S31 (316Ti)
Tie Rods & Nuts	Carbon Steel Grade 8.8 Zinc Plated
Limit Sleeves	Stainless Steel to ASTM Gr. 304/304L

Flanges		
	ASME Class 150	DIN PN10/16
Raised Face Ø	186mm	188mm
Bolt Circle Ø	216mm	210mm
Flange Ø max	333mm	
Bolt Holes ³ [No x Thread]	8 x 3/4"UNC	8 x M16
Thickness	20mm	
Effective Area	17,300mm ²	

Options	
Component	Options
Bellows	Paste Extruded Static-Dissipating ASTM D4895
Flanges	Stainless Steel, Hastelloy, Low Temperature Steels etc.
Root Rings	Hastelloy, Monel etc.
Tie Rods & Nuts	Stainless Steel, Hastelloy, Monel etc.
Anti-Snake Rings	Stainless Steel

Vacuum Performance bar(g)				
Model	20°C	100°C	150°C	200°C
FFB 2 XHD	-1.0	-1.0	-1.0	-1.0
FFB 3 XHD	-1.0	-1.0	-1.0	-1.0
FFB 4 XHD	-1.0	-1.0	-1.0	-1.0
FFB 5 XHD	-1.0	-1.0	-1.0	-1.0

Notes:

- Larger movements are available with more convolutions. These are not combined movements, please refer to page 7 for info.
- Please refer to page 3 for temperature correction factors for spring rate.
- As standard flange holes are threaded. Clearance holes are possible for certain sizes please contact us.
- The maximum number of convolutions for this size is 10, please consult us for further information on these.
- For operating temperature and pressure for more than 5 convolutions please contact us.

FluoroFlow FFB PTFE Bellows are manufactured from virgin or static dissipating paste extruded HiPerFlon® PTFE. They are manufactured using a unique process which ensures a uniform PTFE wall thickness and eliminates stress in the PTFE from the convolution process. These bellows have an Extra Heavy Duty "XHD" liner.

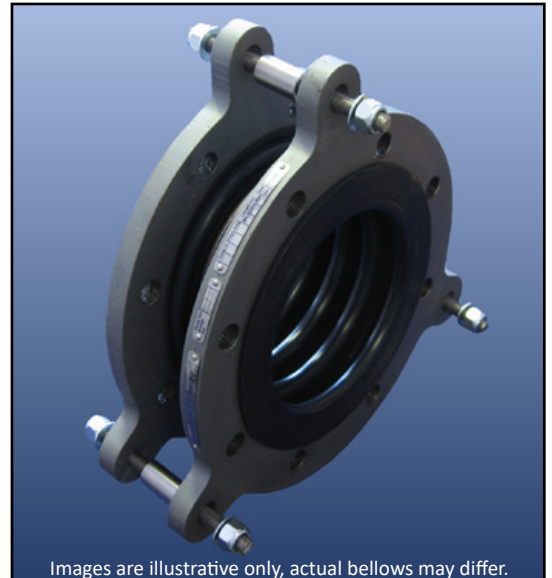
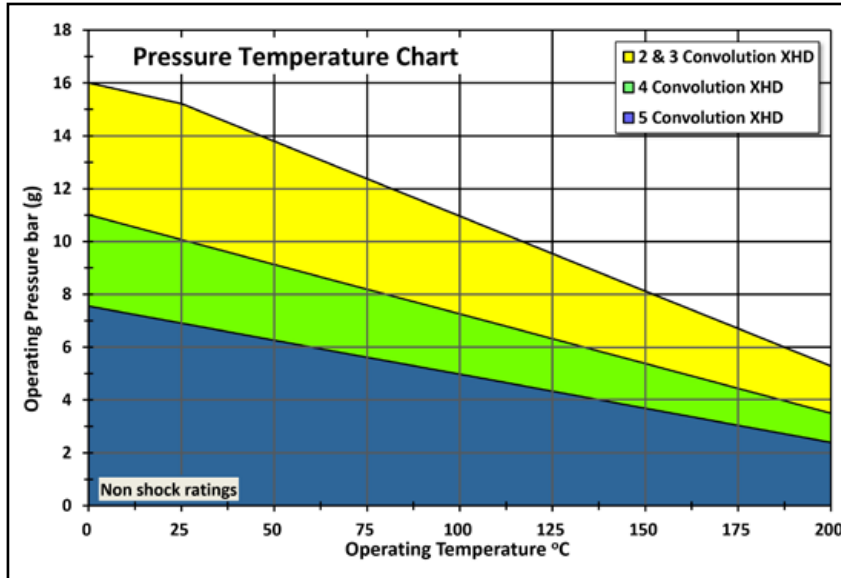

Dimensions and Movements ¹						Weight
Convolutions ⁴	Neutral Length [mm]	Minimum Length [mm]	Maximum Length [mm]	Lateral +/- [mm]	Angular +/- [degrees]	[kg]
FFB 2	75	59	91	8	6	15
FFB 3	103	81	125	12	8	15
FFB 4	131	102	160	17	11	16
FFB 5	159	124	194	21	14	16

Spring Rates ² @ 20°C +/- 50%			
Axial Compression [N/mm]	Axial Extension [N/mm]	Lateral [N/mm]	Angular [Nm/°]
900	300	600	34.8
600	200	400	23.2
450	150	300	17.4
360	120	240	13.9

Materials	
Component	Materials
Bellows	Paste Extruded Virgin PTFE to ASTM D4895
Flanges	Carbon Steel to BS1501-161-430A / P265GH Typical
Paint	Ultra-High Temperature in Silver
Root Rings	Stainless Steel to 320S31 (316Ti)
Tie Rods & Nuts	Carbon Steel Grade 8.8 Zinc Plated
Limit Sleeves	Stainless Steel to ASTM A312 Gr. 304/304L

Flanges		
	ASME Class 150	DIN PN10/16
Raised Face Ø	216mm	212mm
Bolt Circle Ø	241mm	240mm
Flange Ø max	378mm	
Bolt Holes ³ [No x Thread]	8 x 3/4"UNC	8 x M20
Thickness	20mm	
Effective Area	20,900mm ²	

Options	
Component	Options
Bellows	Paste Extruded Static-Dissipating ASTM D4895
Flanges	Stainless Steel, Hastelloy, Low Temperature Steels etc.
Root Rings	Hastelloy, Monel etc.
Tie Rods & Nuts	Stainless Steel, Hastelloy, Monel etc.
Anti-Snake Rings	Stainless Steel

Vacuum Performance bar(g)				
Model	20°C	100°C	150°C	200°C
FFB 2 XHD	-1.0	-1.0	-1.0	-1.0
FFB 3 XHD	-1.0	-1.0	-1.0	-1.0
FFB 4 XHD	-1.0	-1.0	-1.0	-1.0
FFB 5 XHD	-1.0	-1.0	-1.0	-1.0

- Notes:
1. Larger movements are available with more convolutions. These are not combined movements, please refer to page 7 for info.
 2. Please refer to page 5 for temperature correction factors for spring rate.
 3. As standard flange holes are threaded. Clearance holes are possible for certain sizes please contact us.
 4. The maximum number of convolutions for this size is 10, please consult us for further information on these.
 5. For operating temperature and pressure for more than 5 convolutions please contact us.

FluoroFlow FFB PTFE Bellows are manufactured from virgin or static dissipating paste extruded HiPerFlon® PTFE. They are manufactured using a unique process which ensures a uniform PTFE wall thickness and eliminates stress in the PTFE from the convolution process. These bellows have an Extra Heavy Duty "XHD" liner.

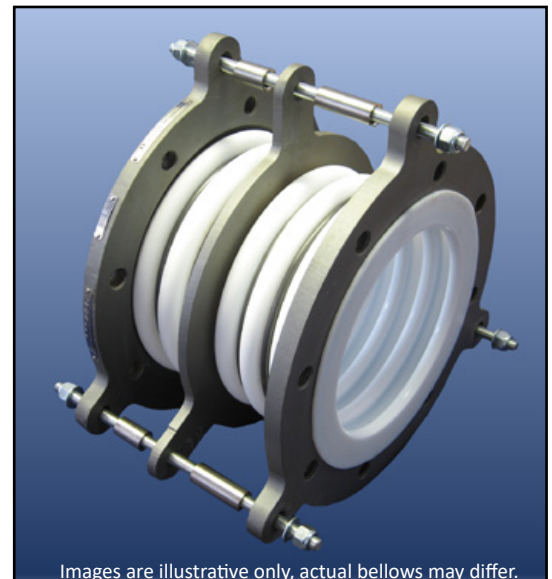
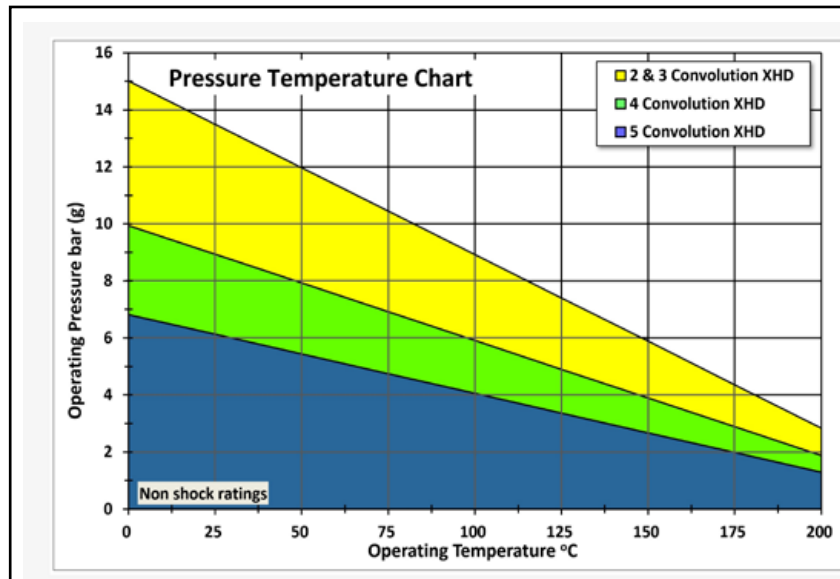

Images are illustrative only, actual bellows may differ.

Dimensions and Movements ¹						Weight
Convolutions ⁴	Neutral Length [mm]	Minimum Length [mm]	Maximum Length [mm]	Lateral +/- [mm]	Angular +/- [degrees]	[kg]
FFB 2	75	58	92	8	5	20
FFB 3	103	79	127	12	8	20
FFB 4	131	100	162	17	10	21
FFB 5	159	121	197	21	12	21

Spring Rates ² @ 20°C +/- 50%			
Axial Compression [N/mm]	Axial Extension [N/mm]	Lateral [N/mm]	Angular [Nm/°]
1089	360	675	71.0
726	240	450	47.3
545	180	338	35.5
436	144	270	28.4

Materials	
Component	Materials
Bellows	Paste Extruded Virgin PTFE to ASTM D4895
Flanges	Carbon Steel to BS1501-161-430A / P265GH Typical
Paint	Ultra-High Temperature in Silver
Root Rings	Stainless Steel to 320S31 (316Ti)
Tie Rods & Nuts	Carbon Steel Grade 8.8 Zinc Plated
Limit Sleeves	Stainless Steel to ASTM A312 Gr. 304/304L

Flanges			
	ASME Class 150	DIN PN10	DIN PN16
Raised Face Ø	270mm	268mm	
Bolt Circle Ø	298mm	295mm	
Flange Ø max	440mm		
Bolt Holes ³ [No x Thread]	8 x 3/4"UNC	8 x M20	12 x M20
Thickness	20mm		
Effective Area	35,300mm ²		

Options	
Bellows	Paste Extruded Static-Dissipating ASTM D4895
Flanges	Stainless Steel, Hastelloy, Low Temperature Steels etc.
Root Rings	Hastelloy, Monel etc.
Tie Rods & Nuts	Stainless steel, Hastelloy, Monel etc.
Anti-Snake Rings	Stainless Steel
Vacuum Support Rings	Hastelloy, Titanium, Tantalum, PTFE Encapsulated etc.

Vacuum Performance bar(g) ⁶				
Model	20°C	100°C	150°C	200°C
FFB 2 XHD	-1.0	-1.0	-1.0	-1.0
FFB 3 XHD	-1.0	-1.0	-1.0	-1.0
FFB 4 XHD	-1.0	-1.0	-1.0	-0.8
FFB 5 XHD	-1.0	-1.0	-1.0	-0.8

Notes:

- Larger movements are available with more convolutions. These are not combined movements, please refer to page 7 for info.
- Please refer to page 5 for temperature correction factors for spring rate.
- As standard flange holes are threaded. Clearance holes are possible for certain sizes please contact us.
- The maximum number of convolutions for this size is 10, please consult us for further information on these.
- For operating temperature and pressure for more than 5 convolutions please contact us.
- Vacuum performance can be increased to full vacuum with the bellows supplied with vacuum support rings.

FluoroFlow FFB PTFE Bellows are manufactured from virgin or static dissipating paste extruded HiPerFlon® PTFE. They are manufactured using a unique process which ensures a uniform PTFE wall thickness and eliminates stress in the PTFE from the convolution process. These bellows have an Extra Heavy Duty "XHD" liner.

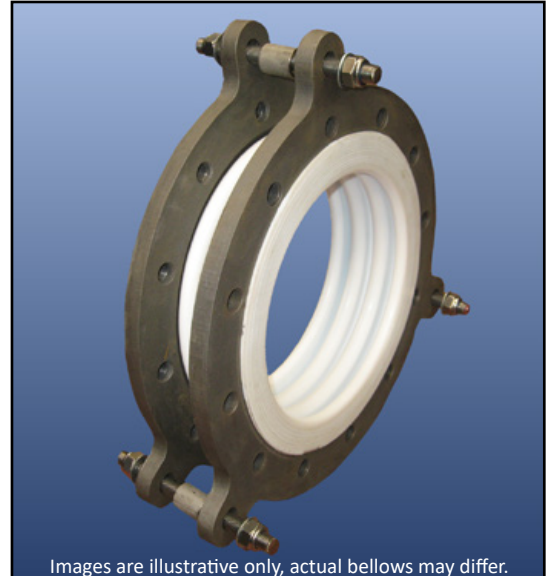
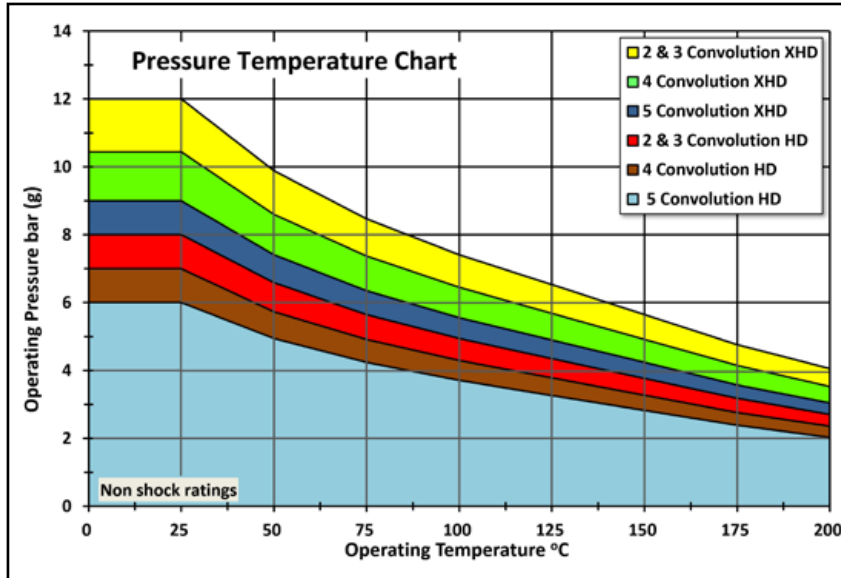

Dimensions and Movements ¹						Weight
Convolutions ⁴	Neutral Length [mm]	Minimum Length [mm]	Maximum Length [mm]	Lateral +/- [mm]	Angular +/- [degrees]	[kg]
FFB 2	78	59	97	8	5	25
FFB 3	107	81	133	12	7	26
FFB 4	135	103	167	17	9	26
FFB 5	164	125	203	21	11	27

Spring Rates ² @ 20°C +/- 50%			
Axial Compression [N/mm]	Axial Extension [N/mm]	Lateral [N/mm]	Angular [Nm/°]
2250	563	488	221
1500	375	325	147
1125	281	244	110
900	225	195	88

Materials	
Component	Materials
Bellows	Paste Extruded Virgin PTFE to ASTM D4895
Flanges	Carbon Steel to BS1501-161-430A / P265GH Typical
Paint	Ultra-High Temperature in Silver
Root Rings	Stainless Steel to 320S31 (316Ti)
Tie Rods & Nuts	Carbon Steel Grade 8.8 Zinc Plated
Limit Sleeves	Stainless Steel to ASTM A312 Gr. 304/304L

Flanges			
	ASME Class 150	DIN PN10	DIN PN16
Raised Face Ø	324mm	320mm	
Bolt Circle Ø	362mm	350mm	355mm
Flange Ø max	514mm		
Bolt Holes ³ [No x Thread]	12 x 7/8"UNC	12 x M20	12 x M24
Thickness	20mm		
Effective Area	56,600mm ²		

Options	
Bellows	Paste Extruded Static-Dissipating ASTM D4895
Flanges	Stainless Steel, Hastelloy, Low Temperature Steels etc.
Root Rings	Hastelloy, Monel etc.
Tie Rods & Nuts	Stainless Steel, Hastelloy, Monel etc.
Anti-Snake Rings	Stainless Steel
Vacuum Support Rings	Hastelloy, Titanium, Tantalum, PTFE Encapsulated etc

Vacuum Performance bar(g) ⁶				
Model	20°C	100°C	150°C	200°C
FFB 2 XHD	-1.0	-1.0	-1.0	-0.9
FFB 3 XHD	-1.0	-1.0	-0.9	-0.8
FFB 4 XHD	-1.0	-0.8	-0.7	-0.6
FFB 5 XHD	-1.0	-0.7	-0.6	-0.6

- Notes:
- Larger movements are available with more convolutions. These are not combined movements, please refer to page 7 for info.
 - Please refer to page 5 for temperature correction factors for spring rate.
 - As standard flange holes are threaded. Clearance holes are possible for certain sizes please contact us.
 - The maximum number of convolutions for this size is 10, please consult us for further information on these.
 - For operating temperature and pressure for more than 5 convolutions please contact us.
 - Vacuum performance can be increased to full vacuum with the bellows supplied with vacuum support rings.

FluoroFlow FFB PTFE Bellows are manufactured from virgin or static dissipating multi-ply HiPerFlon® PTFE. They are manufactured using a unique process which ensures a uniform PTFE wall thickness and eliminates stress in the PTFE from the convolution process. These bellows are available with Heavy Duty “HD” or Extra Heavy Duty “XHD” liners.

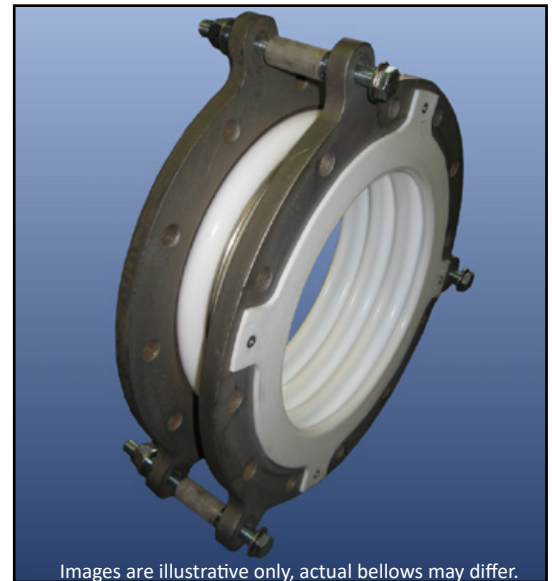
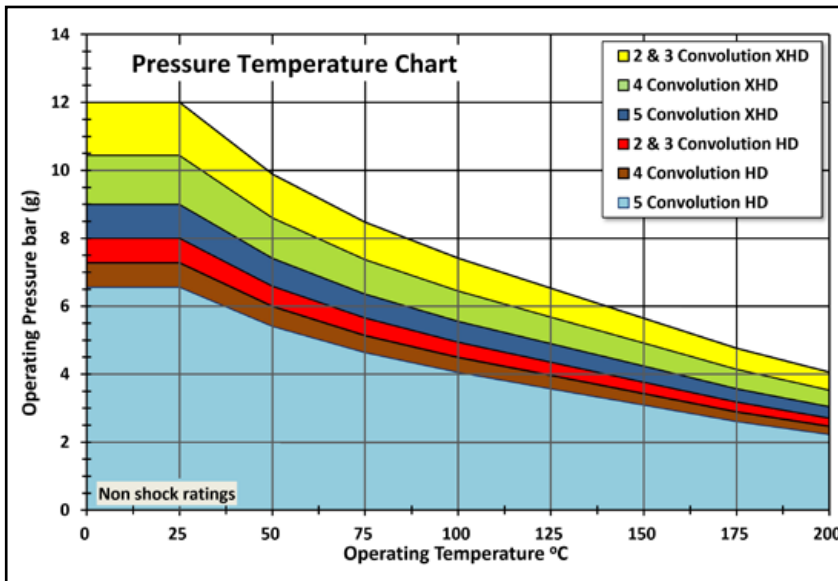

Dimensions and Movements ¹						Weight
Convolutions ⁴	Neutral Length [mm]	Minimum Length [mm]	Maximum Length [mm]	Lateral +/- [mm]	Angular +/- [degrees]	[kg]
FFB 2	95	76	114	9	4	36
FFB 3	132	106	158	13	6	36
FFB 4	169	136	202	18	8	37
FFB 5	206	166	246	22	9	37

Spring Rates ² @ 20°C +/- 50%			
Axial Compression [N/mm]	Axial Extension [N/mm]	Lateral [N/mm]	Angular [Nm/°]
2075	690	636	298
1383	460	424	199
1037	345	318	149
830	276	254	119

Materials	
Component	Materials
Bellows	Multi-ply Virgin PTFE to ASTM D4894 Type IV
Flanges	Carbon Steel to BS1501-161-430A / P265GH Typical
Paint	Ultra-High Temperature in Silver
Root Rings	Stainless Steel to 320S31 (316Ti)
Tie Rods & Nuts	Carbon Steel Grade 8.8 Zinc Plated
Limit Sleeves	Stainless Steel to ASTM A312 Gr. 304/304L

Flanges			
	ASME Class 150	DIN PN10	DIN PN16
Raised Face Ø	381mm	370mm	378mm
Bolt Circle Ø	432mm	400mm	410mm
Flange Ø max	590mm		
Bolt Holes ³ [No x Thread]	12 x 7/8"UNC	12 x M20	12 x M24
Thickness	20mm		
Effective Area	77,700mm ²		

Options	
Component	Options
Bellows	Multi-ply Static-Dissipating ASTM D4894 Type IV
Flanges	Stainless Steel, Hastelloy, Low Temperature Steels etc.
Root Rings	Hastelloy, Monel etc.
Tie Rods & Nuts	Stainless steel, Hastelloy, Monel etc.
Anti-Snake Rings	Stainless Steel to ASTM A312 Gr. 304/304L

Vacuum Performance bar(g) ⁶			
Model	20°C	100°C	150°C
FFB 2 HD	-1.0	-1.0	-0.0
FFB 3 HD	-1.0	-1.0	-0.0
FFB 2 XHD	-1.0	-1.0	-1.0
FFB 3 XHD	-1.0	-1.0	-0.9

Notes:

- Larger movements are available with more convolutions. These are not combined movements, please refer to page 7 for info.
- Please refer to page 5 for temperature correction factors for spring rate.
- As standard flange holes are threaded. Clearance holes are possible for certain sizes please contact us.
- The maximum number of convolutions for this size is 10, please consult us for further information on these.
- For operating temperature and pressure for more than 5 convolutions please contact us.
- Vacuum performance can be increased to full vacuum with the bellows supplied with vacuum support rings.

FluoroFlow FFB PTFE Bellows are manufactured from virgin or static dissipating multi-ply HiPerFlon® PTFE. They are manufactured using a unique process which ensures a uniform PTFE wall thickness and eliminates stress in the PTFE from the convolution process. These bellows are available with Heavy Duty "HD" or Extra Heavy Duty "XHD" liners.

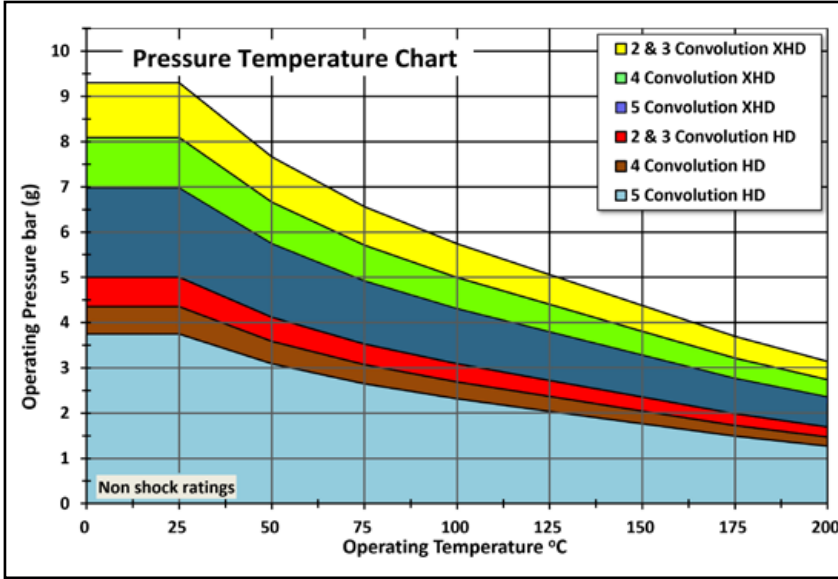

Dimensions and Movements ¹						Weight
Convolutions ⁴	Neutral Length [mm]	Minimum Length [mm]	Maximum Length [mm]	Lateral +/- [mm]	Angular +/- [degrees]	[kg]
FFB 2	98	78	118	8	3	65
FFB 3	137	110	164	12	5	66
FFB 4	176	142	210	17	6	67
FFB 5	215	174	256	21	7	68

Spring Rates ² @ 20°C +/- 50%			
Axial Compression [N/mm]	Axial Extension [N/mm]	Lateral [N/mm]	Angular [Nm/°]
1554	1020	1008	384
1036	680	672	256
777	510	504	192
622	408	403	153

Materials	
Component	Materials
Bellows	Multi-ply Virgin PTFE to ASTM D4894 Type IV
Flanges	Carbon Steel to BS1501-161-430A / P265GH Typical
Paint	Ultra-High Temperature in Silver
Root Rings	Stainless Steel to 320S31 (316Ti)
Tie Rods & Nuts	Carbon Steel Grade 8.8 Zinc Plated
Limit Sleeves	Stainless Steel to ASTM A312 Gr. 304/304L

Flanges			
	ASME Class 150	DIN PN10	DIN PN16
Raised Face Ø	413mm	430mm	438mm
Bolt Circle Ø	476mm	460mm	470mm
Flange Ø max	640mm		
Bolt Holes ³ [No x Thread]	12 x 1"UNC	16 x M20	16 x M24
Thickness	22mm		
Effective Area	107,400mm ²		

Options	
Component	Options
Bellows	Multi-ply Static-Dissipating ASTM D4894 Type IV
Flanges	Stainless Steel, Hastelloy, Low Temperature Steels etc.
Root Rings	Hastelloy, Monel etc.
Tie Rods & Nuts	Stainless Steel, Hastelloy, Monel etc.
Anti-Snake Rings	Stainless Steel

Vacuum Performance

Whilst the standard bellows are not suitable for use under vacuum, they can be supplied with internal vacuum support rings to provide full vacuum performance. Vacuum support rings can be manufactured from Hastelloy, Titanium, Tantalum or PTFE encapsulated etc.

- Notes:
1. Larger movements are available with more convolutions. These are not combined movements, please refer to page 7 for info.
 2. Please refer to page 5 for temperature correction factors for spring rate.
 3. As standard flange holes are threaded. Clearance holes are possible for certain sizes please contact us.
 4. The maximum number of convolutions for this size is 7, please consult us for further information on these.
 5. For operating temperature and pressure for more than 5 convolutions please contact us.

FluoroFlow FFB PTFE Bellows are manufactured from virgin or static dissipating multi-ply HiPerFlon® PTFE. They are manufactured using a unique process which ensures a uniform PTFE wall thickness and eliminates stress in the PTFE from the convolution process. These bellows are available with Heavy Duty “HD” or Extra Heavy Duty “XHD” liners.

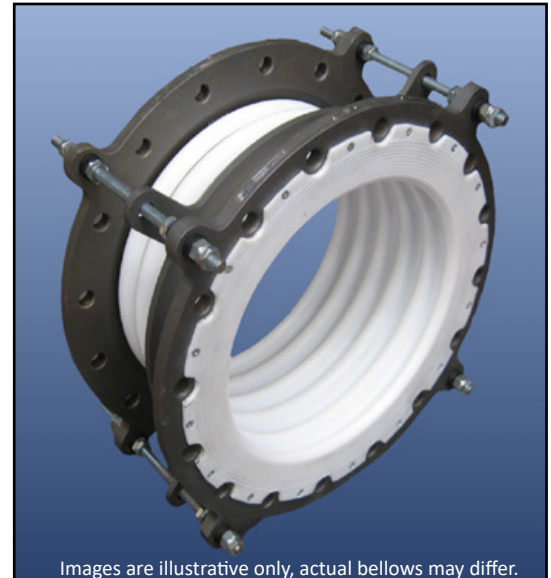
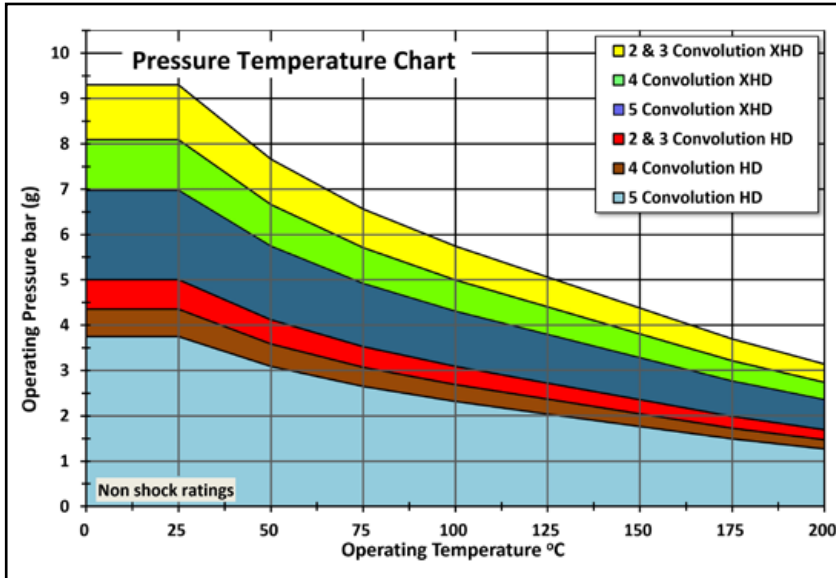

Dimensions and Movements ¹						Weight
Convolutions ⁴	Neutral Length [mm]	Minimum Length [mm]	Maximum Length [mm]	Lateral +/- [mm]	Angular +/- [degrees]	[kg]
FFB 2	117	97	137	10	3	79
FFB 3	162	134	190	15	4	80
FFB 4	207	171	243	20	6	81
FFB 5	252	208	296	25	7	83

Spring Rates ² @ 20°C +/- 50%			
Axial Compression [N/mm]	Axial Extension [N/mm]	Lateral [N/mm]	Angular [Nm/°]
1455	870	1380	57
970	580	920	38
728	435	690	29
582	348	552	23

Materials	
Component	Materials
Bellows	Multi-ply Virgin PTFE to ASTM D4894 Type IV
Flanges	Carbon Steel to BS1501-161-430A / P265GH Typical
Paint	Ultra-High Temperature in Silver
Root Rings	Stainless Steel to 320S31 (316Ti)
Tie Rods & Nuts	Carbon Steel Grade 8.8 Zinc Plated
Limit Sleeves	Stainless Steel to ASTM A312 Gr. 304/304L

Flanges			
	ASME Class 150	DIN PN10	DIN PN16
Raised Face Ø	470mm	482mm	490mm
Bolt Circle Ø	540mm	515mm	525mm
Flange Ø max	700mm		
Bolt Holes ³ [No x Thread]	16 x 1"UNC	16 x M24	16 x M27
Thickness	20mm		
Effective Area	141,100mm ²		

Options	
Component	Options
Bellows	Multi-ply Static-Dissipating ASTM D4894 Type IV
Flanges	Stainless Steel, Hastelloy, Low Temperature Steels etc.
Root Rings	Hastelloy, Monel etc.
Tie Rods & Nuts	Stainless steel, Hastelloy, Monel etc.
Anti-Snake Rings	Stainless Steel

Vacuum Performance

Whilst the standard bellows are not suitable for use under vacuum, they can be supplied with internal vacuum support rings to provide full vacuum performance. Vacuum support rings can be manufactured from Hastelloy, Titanium, Tantalum or PTFE encapsulated etc.

Notes:

1. Larger movements are available with more convolutions. These are not combined movements, please refer to page 7 for info.
2. Please refer to page 5 for temperature correction factors for spring rate.
3. As standard flange holes are threaded. Clearance holes are possible for certain sizes please contact us.
4. The maximum number of convolutions for this size is 10, please consult us for further information on these.
5. For operating temperature and pressure for more than 5 convolutions please contact us.

FluoroFlow FFB PTFE Bellows are manufactured from virgin or static dissipating multi-ply HiPerFlon® PTFE. They are manufactured using a unique process which ensures a uniform PTFE wall thickness and eliminates stress in the PTFE from the convolution process. These bellows are available with Heavy Duty "HD" or Extra Heavy Duty "XHD" liners.

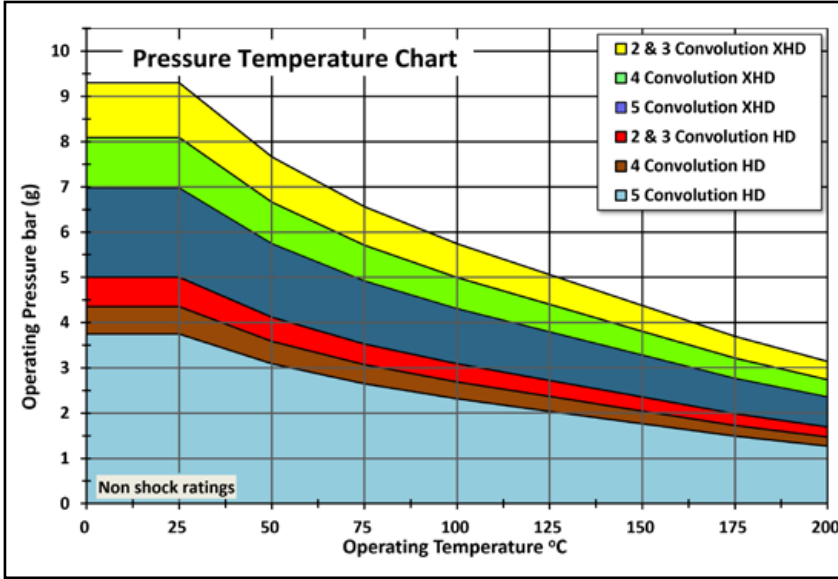

Dimensions and Movements ¹						Weight
Convolutions ⁴	Neutral Length [mm]	Minimum Length [mm]	Maximum Length [mm]	Lateral +/- [mm]	Angular +/- [degrees]	[kg]
FFB 2	118	98	138	11	3	82
FFB 3	163	135	191	15	4	84
FFB 4	208	172	244	20	5	85
FFB 5	253	209	297	24	7	86

Spring Rates ² @ 20°C +/- 50%			
Axial Compression [N/mm]	Axial Extension [N/mm]	Lateral [N/mm]	Angular [Nm/°]
2325	1290	1553	66
1550	860	1035	44
1163	645	776	33
930	516	621	26

Materials	
Component	Materials
Bellows	Multi-ply Virgin PTFE to ASTM D4894 Type IV
Flanges	Carbon Steel to BS1501-161-430A / P265GH Typical
Paint	Ultra-High Temperature in Silver
Root Rings	Stainless Steel to 320S31 (316Ti)
Tie Rods & Nuts	Carbon Steel Grade 8.8 Zinc Plated
Limit Sleeves	Stainless Steel to ASTM A312 Gr. 304/304L

Flanges			
	ASME Class 150	DIN PN10	DIN PN16
Raised Face Ø	533mm	532mm	550mm
Bolt Circle Ø	578mm	565mm	585mm
Flange Ø max	740mm		
Bolt Holes ³ [No x Thread]	16 x 1.1/8"UNC	20 x M24	20 x M27
Thickness	22mm		
Effective Area	180,000mm ²		

Options	
Component	Materials
Bellows	Multi-ply Static-Dissipating ASTM D4894 Type IV
Flanges	Stainless Steel, Hastelloy, Low Temperature Steels etc.
Root Rings	Hastelloy, Monel etc.
Tie Rods & Nuts	Stainless Steel, Hastelloy, Monel etc.
Anti-Snake Rings	Stainless Steel

Vacuum Performance

Whilst the standard bellows are not suitable for use under vacuum, they can be supplied with internal vacuum support rings to provide full vacuum performance. Vacuum support rings can be manufactured from Hastelloy, Titanium, Tantalum or PTFE encapsulated etc.

- Notes:
1. Larger movements are available with more convolutions. These are not combined movements, please refer to page 7 for info.
 2. Please refer to page 5 for temperature correction factors for spring rate.
 3. As standard flange holes are threaded. Clearance holes are possible for certain sizes please contact us.
 4. The maximum number of convolutions for this size is 10, please consult us for further information on these.
 5. For operating temperature and pressure for more than 5 convolutions please contact us.

FluoroFlow FFB PTFE Bellows are manufactured from virgin or static dissipating multi-ply HiPerFlon® PTFE. They are manufactured using a unique process which ensures a uniform PTFE wall thickness and eliminates stress in the PTFE from the convolution process. These bellows are available with Heavy Duty “HD” or Extra Heavy Duty “XHD” liners.

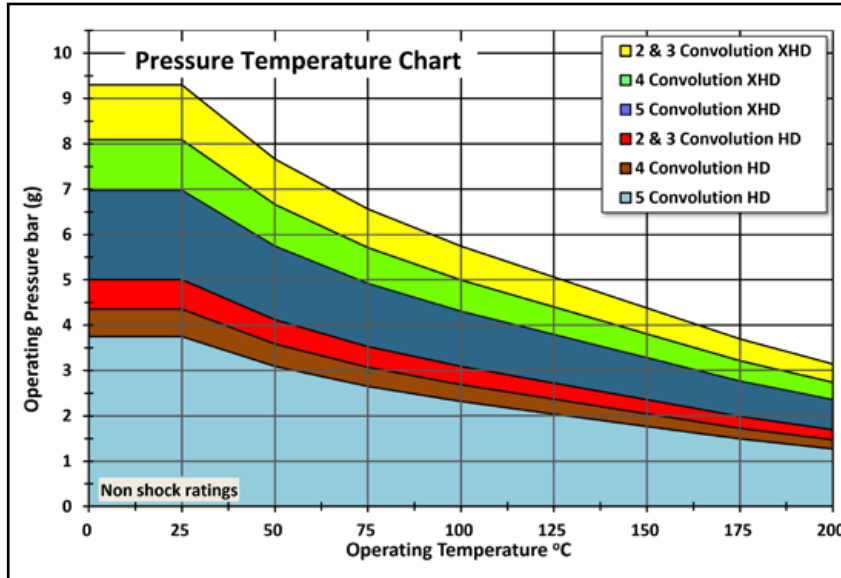

Dimensions and Movements ¹						Weight
Convolutions ⁴	Neutral Length [mm]	Minimum Length [mm]	Maximum Length [mm]	Lateral +/- [mm]	Angular +/- [degrees]	[kg]
FFB 2	125	105	145	11	2	104
FFB 3	170	142	198	15	4	106
FFB 4	215	179	251	20	5	108
FFB 5	260	216	304	24	6	109

Spring Rates ² @ 20°C +/- 50%			
Axial Compression [N/mm]	Axial Extension [N/mm]	Lateral [N/mm]	Angular [Nm/°]
2865	1605	1725	74
1910	1070	1150	50
1433	803	863	37
1146	642	690	30

Materials	
Component	Materials
Bellows	Multi-ply Virgin PTFE to ASTM D4894 Type IV
Flanges	Carbon Steel to BS1501-161-430A / P265GH Typical
Paint	Ultra-High Temperature in Silver
Root Rings	Stainless Steel to 320S31 (316Ti)
Tie Rods & Nuts	Carbon Steel Grade 8.8 Zinc Plated
Limit Sleeves	Stainless Steel to ASTM A312 Gr. 304/304L

Flanges			
	ASME Class 150	DIN PN10	DIN PN16
Raised Face Ø	584mm	585mm	610mm
Bolt Circle Ø	635mm	620mm	650mm
Flange Ø max	830mm		
Bolt Holes ³ [No x Thread]	20 x 1.1/8"UNC	20 x M24	20 x M30
Thickness	25mm		
Effective Area	216,400mm ²		

Options	
Component	Options
Bellows	Multi-ply Static-Dissipating ASTM D4894 Type IV
Flanges	Stainless Steel, Hastelloy, Low Temperature Steels etc.
Root Rings	Hastelloy, Monel etc.
Tie Rods & Nuts	Stainless steel, Hastelloy, Monel etc.
Anti-Snake Rings	Stainless Steel

Vacuum Performance

Whilst the standard bellows are not suitable for use under vacuum, they can be supplied with internal vacuum support rings to provide full vacuum performance. Vacuum support rings can be manufactured from Hastelloy, Titanium, Tantalum or PTFE encapsulated etc.

Notes:

1. Larger movements are available with more convolutions. These are not combined movements, please refer to page 7 for info.
2. Please refer to page 5 for temperature correction factors for spring rate.
3. As standard flange holes are threaded. Clearance holes are possible for certain sizes please contact us.
4. The maximum number of convolutions for this size is 10, please consult us for further information on these.
5. For operating temperature and pressure for more than 5 convolutions please contact us.

FluoroFlow FFB PTFE Bellows are manufactured from virgin or static dissipating multi-ply HiPerFlon® PTFE. They are manufactured using a unique process which ensures a uniform PTFE wall thickness and eliminates stress in the PTFE from the convolution process. These bellows are available with Heavy Duty “HD” or Extra Heavy Duty “XHD” liners.

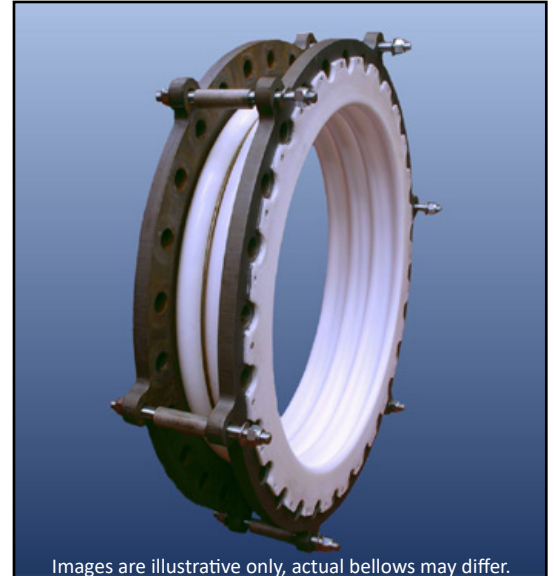
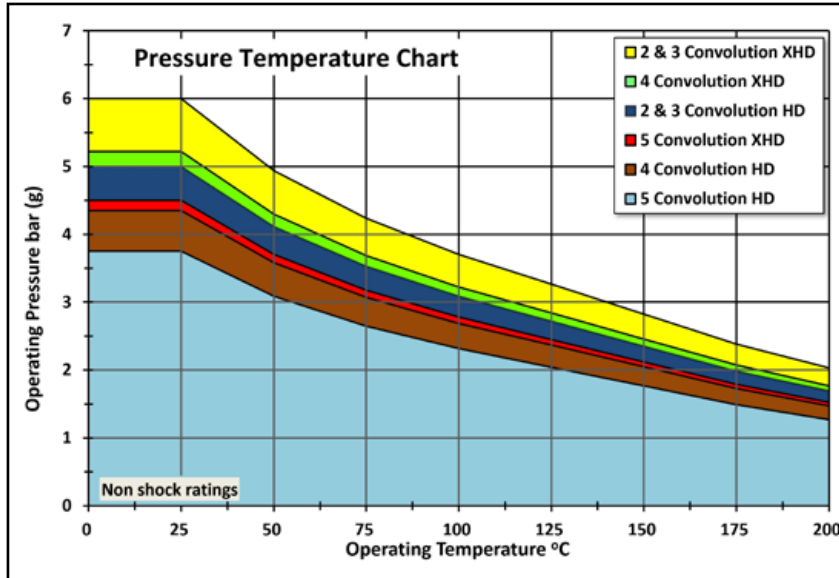

Dimensions and Movements ¹						Weight
Convolutions ⁴	Neutral Length [mm]	Minimum Length [mm]	Maximum Length [mm]	Lateral +/- [mm]	Angular +/- [degrees]	[kg]
FFB 2	130	110	150	11	2	140
FFB 3	175	147	203	15	3	142
FFB 4	220	183	257	20	4	145
FFB 5	265	220	310	24	5	147

Spring Rates ² @ 20°C +/- 50%			
Axial Compression [N/mm]	Axial Extension [N/mm]	Lateral [N/mm]	Angular [Nm/°]
2865	1605	1725	74
1910	1070	1150	50
1433	803	863	37
1146	642	690	30

Materials	
Component	Materials
Bellows	Multi-ply Virgin PTFE to ASTM D4894 Type IV
Flanges	Carbon Steel to BS1501-161-430A / P265GH Typical
Paint	Ultra-High Temperature in Silver
Root Rings	Stainless Steel to 320S31 (316Ti)
Tie Rods & Nuts	Carbon Steel Grade 8.8 Zinc Plated
Limit Sleeves	Stainless Steel to ASTM A312 Gr. 304/304L

Flanges			
	ASME Class 150	DIN PN10	DIN PN16
Raised Face Ø	692mm	685mm	725mm
Bolt Circle Ø	749mm	725mm	770mm
Flange Ø max	935mm	900mm	960mm
Bolt Holes ³ [No x Thread]	20 x 1.1/4"UNC	20 x M27	20 x M33
Thickness	25mm		
Effective Area	307,700mm ²		

Options	
Component	Materials
Bellows	Multi-ply Static-Dissipating ASTM D4894 Type IV
Flanges	Stainless Steel, Hastelloy, Low Temperature Steels etc.
Root Rings	Hastelloy, Monel etc.
Tie Rods & Nuts	Stainless Steel, Hastelloy, Monel etc.
Anti-Snake Rings	Stainless Steel

Vacuum Performance

Whilst the standard bellows are not suitable for use under vacuum, they can be supplied with internal vacuum support rings to provide full vacuum performance. Vacuum support rings can be manufactured from Hastelloy, Titanium, Tantalum or PTFE encapsulated etc.

- Notes:
1. Larger movements are available with more convolutions. These are not combined movements, please refer to page 7 for info.
 2. Please refer to page 5 for temperature correction factors for spring rate.
 3. As standard flange holes are threaded. Clearance holes are possible for certain sizes please contact us.
 4. The maximum number of convolutions for this size is 6, please consult us for further information on these.
 5. For operating temperature and pressure for more than 5 convolutions please contact us.

FluoroFlow FFB PTFE Bellows are manufactured from virgin or static dissipating multi-ply HiPerFlon® PTFE. They are manufactured using a unique process which ensures a uniform PTFE wall thickness and eliminates stress in the PTFE from the convolution process. These bellows are available with Heavy Duty “HD” or Extra Heavy Duty “XHD” liners.

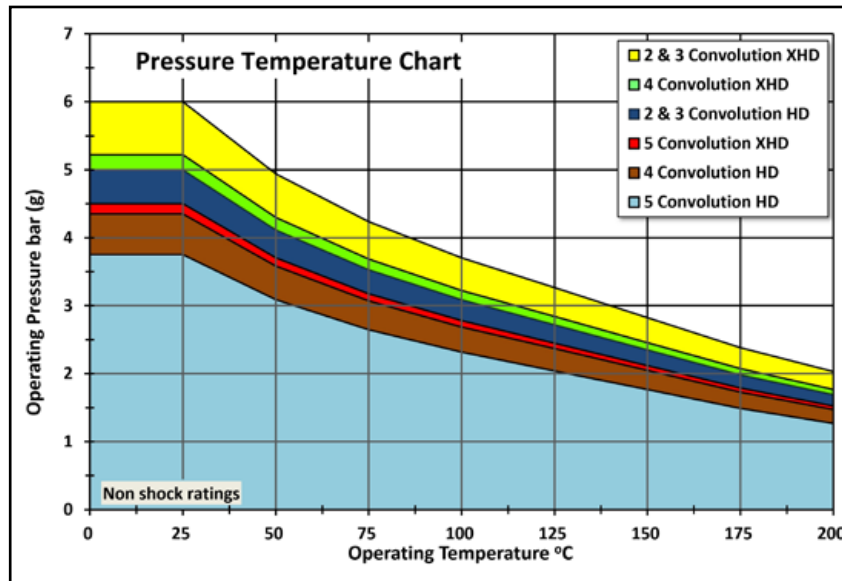

Dimensions and Movements ¹						Weight
Convolutions ⁴	Neutral Length [mm]	Minimum Length [mm]	Maximum Length [mm]	Lateral +/- [mm]	Angular +/- [degrees]	[kg]
FFB 2	146	121	171	12	2	154
FFB 3	207	175	239	16	3	157
FFB 4	268	229	307	20	3	160
FFB 5	329	283	375	24	4	163

Spring Rates ² @ 20°C +/- 50%			
Axial Compression [N/mm]	Axial Extension [N/mm]	Lateral [N/mm]	Angular [Nm/°]
3120	2415	5745	135
2080	1610	3830	90
1561	1208	2873	67
1248	966	2298	54

Materials	
Component	Materials
Bellows	Multi-ply Virgin PTFE to ASTM D4894 Type IV
Flanges	Carbon Steel to BS1501-161-430A / P265GH Typical
Paint	Ultra-High Temperature in Silver
Root Rings	Stainless Steel to 320S31 (316Ti)
Tie Rods & Nuts	Carbon Steel Grade 8.8 Zinc Plated
Limit Sleeves	Stainless Steel to ASTM A312 Gr. 304/304L

	ASME Class 150		DIN	DIN
	Series A	Series B	PN10	PN16
Raised Face Ø	800mm	762mm	800mm	795mm
Bolt Circle Ø	864mm	795mm	840mm	
Flange Ø max	1060mm	970mm	1028mm	1043mm
Bolt Holes ³ [No x Thread]	28 x 1.1/4" UNC	40 x 3/4" UNC	24 x M27	24 x M33
Thickness	27mm			
Effective Area	422,800mm ²			

Options	
Component	Materials
Bellows	Multi-ply Static-Dissipating ASTM D4894 Type IV
Flanges	Stainless Steel, Hastelloy, Low Temperature Steels etc.
Root Rings	Hastelloy, Monel etc.
Tie Rods & Nuts	Stainless steel, Hastelloy, Monel etc.
Anti-Snake Rings	Stainless Steel

Vacuum Performance

Whilst the standard bellows are not suitable for use under vacuum, they can be supplied with internal vacuum support rings to provide full vacuum performance. Vacuum support rings can be manufactured from Hastelloy, Titanium, Tantalum or PTFE encapsulated etc.

Notes:

1. Larger movements are available with more convolutions. These are not combined movements, please refer to page 7 for info.
2. Please refer to page 5 for temperature correction factors for spring rate.
3. As standard flange holes are threaded. Clearance holes are possible for certain sizes please contact us.
4. The maximum number of convolutions for this size is 6, please consult us for further information on these.
5. For operating temperature and pressure for more than 5 convolutions please contact us.

FluoroFlow FFB PTFE Bellows are manufactured from virgin or static dissipating multi-ply HiPerFlon® PTFE. They are manufactured using a unique process which ensures a uniform PTFE wall thickness and eliminates stress in the PTFE from the convolution process. These bellows are available with Heavy Duty “HD” or Extra Heavy Duty “XHD” liners.

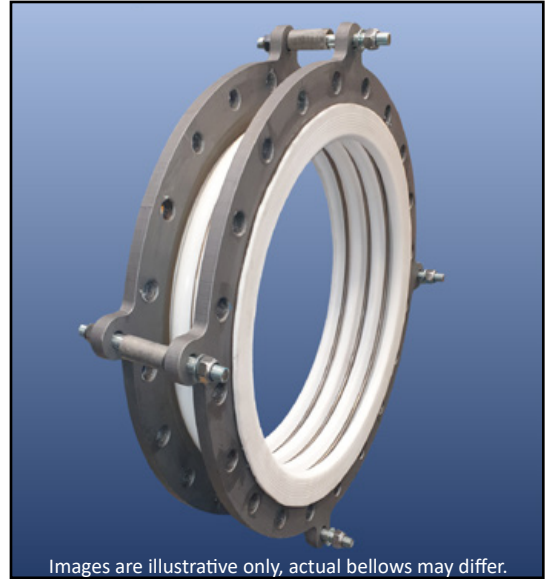
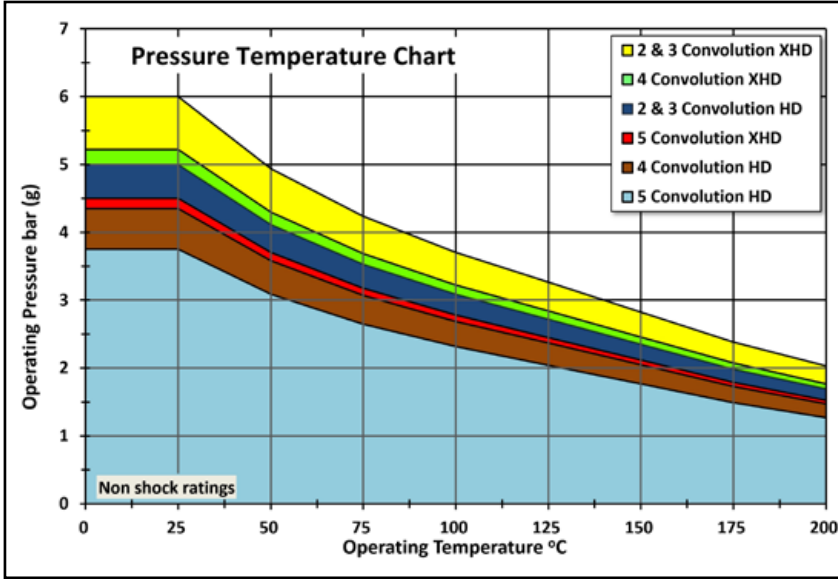

Dimensions and Movements ¹						Weight
Convolutions ⁴	Neutral Length [mm]	Minimum Length [mm]	Maximum Length [mm]	Lateral +/- [mm]	Angular +/- [degrees]	[kg]
FFB 2	160	135	185	11	2	178
FFB 3	221	189	251	15	3	181
FFB 4	282	243	321	19	3	184
FFB 5	343	297	389	23	4	187

Spring Rates ² @ 20°C +/- 50%			
Axial Compression [N/mm]	Axial Extension [N/mm]	Lateral [N/mm]	Angular [Nm/°]
3340	2590	6145	145
2225	1725	4100	100
1670	1294	3076	73
1336	1035	2460	58

Materials	
Component	Materials
Bellows	Multi-ply Virgin PTFE to ASTM D4894 Type IV
Flanges	Carbon Steel to BS1501-161-430A / P265GH Typical
Paint	Ultra-High Temperature in Silver
Root Rings	Stainless Steel to 320S31 (316Ti)
Tie Rods & Nuts	Carbon Steel Grade 8.8 Zinc Plated
Limit Sleeves	Stainless Steel to ASTM A312 Gr. 304/304L

Flanges		
	ASME Class 150 Series A	ASME Class 150 Series B
Raised Face Ø	857mm	813mm
Bolt Circle Ø	914mm	846mm
Flange Ø max	1117mm	1020mm
Bolt Holes ³ [No x Thread]	28 x 1.1/4"UNC	44 x 3/4"UNC
Thickness	27mm	
Effective Area	471,700mm ²	

Options	
Component	Materials
Bellows	Multi-ply Static-Dissipating ASTM D4894 Type IV
Flanges	Stainless Steel, Hastelloy, Low Temperature Steels etc.
Root Rings	Hastelloy, Monel etc.
Tie Rods & Nuts	Stainless Steel, Hastelloy, Monel etc.
Anti-Snake Rings	Stainless Steel

Vacuum Performance

Whilst the standard bellows are not suitable for use under vacuum, they can be supplied with internal vacuum support rings to provide full vacuum performance. Vacuum support rings can be manufactured from Hastelloy, Titanium, Tantalum or PTFE encapsulated etc.

- Notes:
1. Larger movements are available with more convolutions. These are not combined movements, please refer to page 7 for info.
 2. Please refer to page 5 for temperature correction factors for spring rate.
 3. As standard flange holes are threaded. Clearance holes are possible for certain sizes please contact us.
 4. The maximum number of convolutions for this size is 6, please consult us for further information on these.
 5. For operating temperature and pressure for more than 5 convolutions please contact us.

FluoroFlow FFB PTFE Bellows are manufactured from virgin or static dissipating multi-ply HiPerFlon® PTFE. They are manufactured using a unique process which ensures a uniform PTFE wall thickness and eliminates stress in the PTFE from the convolution process. These bellows are available with Heavy Duty “HD” or Extra Heavy Duty “XHD” liners.

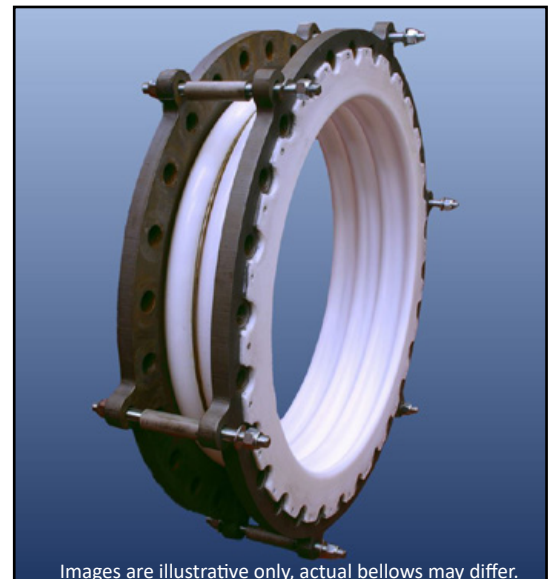
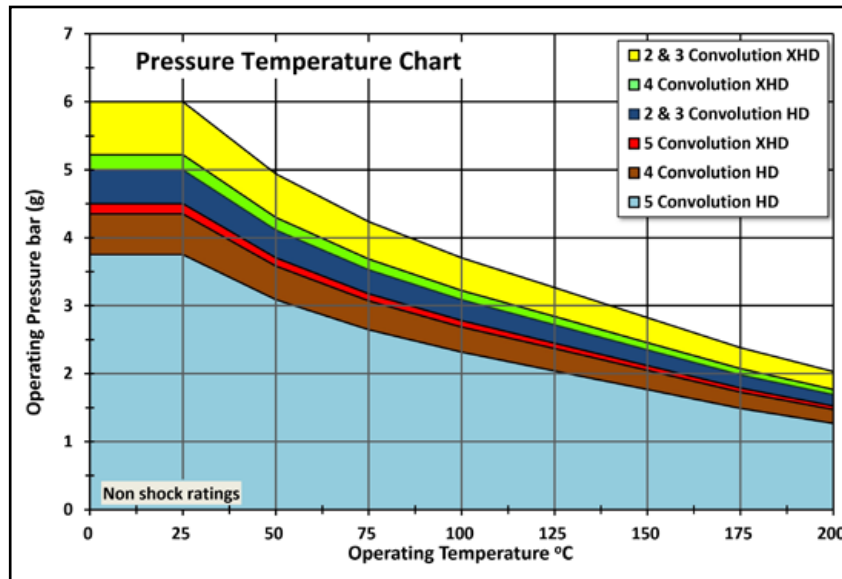

Dimensions and Movements ¹						Weight
Convolutions ⁴	Neutral Length [mm]	Minimum Length [mm]	Maximum Length [mm]	Lateral +/- [mm]	Angular +/- [degrees]	[kg]
FFB 2	160	135	185	11	2	202
FFB 3	221	189	251	15	3	206
FFB 4	282	243	321	19	3	210
FFB 5	343	297	389	23	4	214

Spring Rates ² @ 20°C +/- 50%			
Axial Compression [N/mm]	Axial Extension [N/mm]	Lateral [N/mm]	Angular [Nm/°]
3560	2750	6550	153
2373	1833	4367	102
1780	1375	3275	77
1424	1100	2620	61

Materials	
Component	Materials
Bellows	Multi-ply Virgin PTFE to ASTM D4894 Type IV
Flanges	Carbon Steel to BS1501-161-430A / P265GH Typical
Paint	Ultra-High Temperature in Silver
Root Rings	Stainless Steel to 320S31 (316Ti)
Tie Rods & Nuts	Carbon Steel Grade 8.8 Zinc Plated
Limit Sleeves	Stainless Steel to ASTM A312 Gr. 304/304L

	ASME Class 150		DIN PN10	DIN PN16
	Series A	Series B		
Raised Face Ø	914mm	864mm	905mm	900mm
Bolt Circle Ø	978mm	900mm	950mm	
Flange Ø max	1170mm	1070mm	1125mm	1135mm
Bolt Holes ³ [No x Thread]	28 x 1.1/2" UNC	48 x 3/4" UNC	24 x M30	24 x M36
Thickness	30mm			
Effective Area	550,900mm ²			

Options	
Component	Options
Bellows	Multi-ply Static-Dissipating ASTM D4894 Type IV
Flanges	Stainless Steel, Hastelloy, Low Temperature Steels etc.
Root Rings	Hastelloy, Monel etc.
Tie Rods & Nuts	Stainless steel, Hastelloy, Monel etc.
Anti-Snake Rings	Stainless Steel

Vacuum Performance

Whilst the standard bellows are not suitable for use under vacuum, they can be supplied with internal vacuum support rings to provide full vacuum performance. Vacuum support rings can be manufactured from Hastelloy, Titanium, Tantalum or PTFE encapsulated etc.

Notes:

- Larger movements are available with more convolutions. These are not combined movements, please refer to page 7 for info.
- Please refer to page 5 for temperature correction factors for spring rate.
- As standard flange holes are threaded. Clearance holes are possible for certain sizes please contact us.
- The maximum number of convolutions for this size is 6, please consult us for further information on these.
- For operating temperature and pressure for more than 5 convolutions please contact us.

FluoroFlow FFB PTFE Bellows are manufactured from virgin or static dissipating multi-ply HiPerFlon® PTFE. They are manufactured using a unique process which ensures a uniform PTFE wall thickness and eliminates stress in the PTFE from the convolution process. These bellows are available with Heavy Duty "HD" or Extra Heavy Duty "XHD" liners.

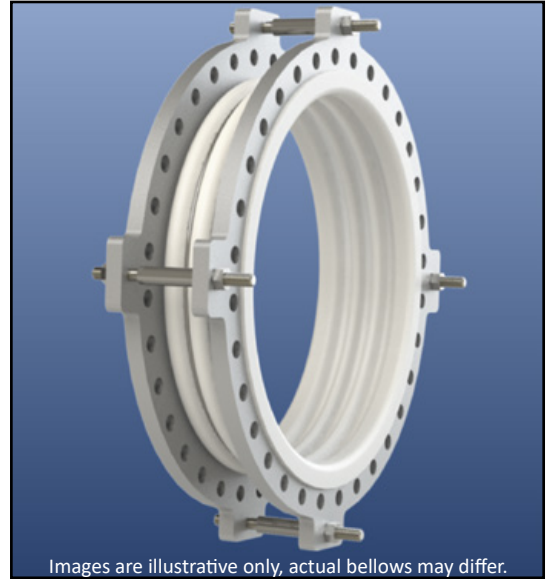
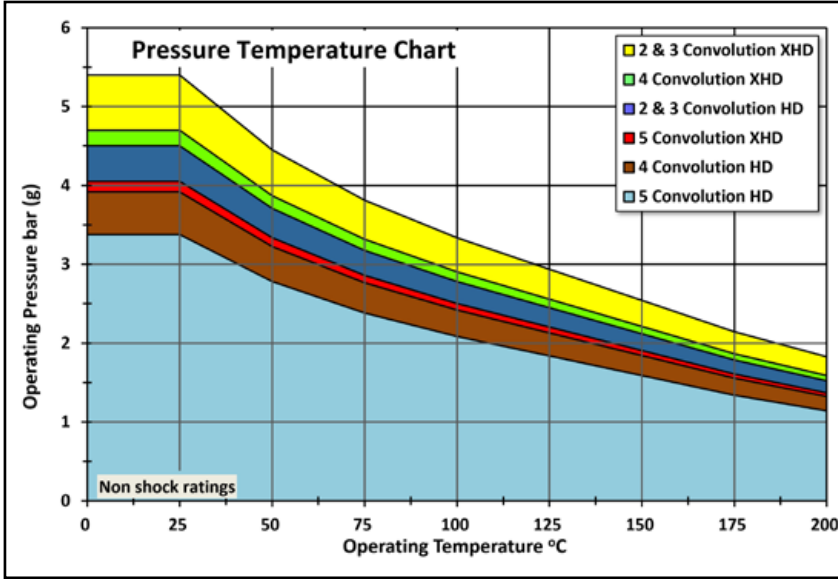

Dimensions and Movements ¹						Weight
Convolutions ⁴	Neutral Length [mm]	Minimum Length [mm]	Maximum Length [mm]	Lateral +/- [mm]	Angular +/- [degrees]	[kg]
FFB 2	240	215	265	11	2	310
FFB 3	307	275	339	15	3	318
FFB 4	374	335	413	19	3	326
FFB 5	441	395	487	23	4	334

Spring Rates ² @ 20°C +/- 50%			
Axial Compression [N/mm]	Axial Extension [N/mm]	Lateral [N/mm]	Angular [Nm/°]
4110	3110	7370	172
2740	2067	4914	114
2055	1550	3685	86
1644	1240	2948	68

Materials	
Component	Materials
Bellows	Multi-ply Virgin PTFE to ASTM D4894 Type IV
Flanges	Carbon Steel to BS1501-161-430A / P265GH Typical
Paint	Ultra-High Temperature in Silver
Root Rings	Stainless Steel to 320S31 (316Ti)
Tie Rods & Nuts	Carbon Steel Grade 8.8 Zinc Plated
Limit Sleeves	Stainless Steel to ASTM A312 Gr. 304/304L

	ASME Class 150		DIN	DIN
	Series A	Series B	PN10	PN16
Raised Face Ø	1022mm	972mm	1005mm	1000mm
Bolt Circle Ø	1086mm	1010mm	1050mm	
Flange Ø max	1278mm	1167mm	1225mm	1235mm
Bolt Holes ³ [No x Thread]	32 x 1.1/2" UNC	44 x 7/8" UNC	28 x M30	28 x M36
Thickness	45mm			
Effective Area	670,200mm ²			

Options	
Component	Materials
Bellows	Multi-ply Static-Dissipating ASTM D4894 Type IV
Flanges	Stainless Steel, Hastelloy, Low Temperature Steels etc.
Root Rings	Hastelloy, Monel etc.
Tie Rods & Nuts	Stainless Steel, Hastelloy, Monel etc.
Anti-Snake Rings	Stainless Steel

Vacuum Performance

Whilst the standard bellows are not suitable for use under vacuum, they can be supplied with internal vacuum support rings to provide full vacuum performance. Vacuum support rings can be manufactured from Hastelloy, Titanium, Tantalum or PTFE encapsulated etc.

- Notes:
1. Larger movements are available with more convolutions. These are not combined movements, please refer to page 7 for info.
 2. Please refer to page 5 for temperature correction factors for spring rate.
 3. As standard flange holes are threaded. Clearance holes are possible for certain sizes please contact us.
 4. The maximum number of convolutions for this size is 6, please consult us for further information on these.
 5. For operating temperature and pressure for more than 5 convolutions please contact us.

FluoroFlow FFB PTFE Bellows are manufactured from virgin or static dissipating multi-ply HiPerFlon® PTFE. They are manufactured using a unique process which ensures a uniform PTFE wall thickness and eliminates stress in the PTFE from the convolution process. These bellows are available with Heavy Duty “HD” or Extra Heavy Duty “XHD” liners.

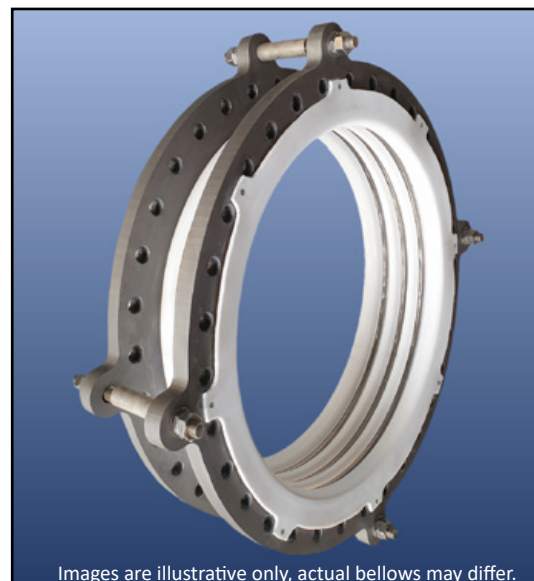
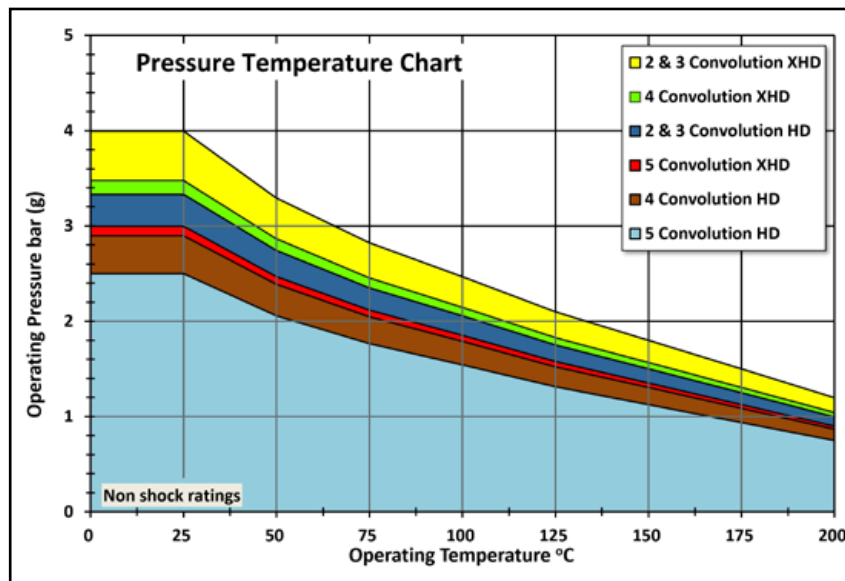

Dimensions and Movements ¹						Weight
Convolutions ⁴	Neutral Length [mm]	Minimum Length [mm]	Maximum Length [mm]	Lateral +/- [mm]	Angular +/- [degrees]	[kg]
FFB 2	261	236	286	11	2	512
FFB 3	326	294	358	15	2.5	518
FFB 4	391	352	430	19	3	524
FFB 5	456	410	502	23	3.5	530

Spring Rates ² @ 20°C +/- 50%			
Axial Compression [N/mm]	Axial Extension [N/mm]	Lateral [N/mm]	Angular [Nm/°]
4825	3610	8585	200
3217	2407	5725	132
2412	1805	4292	101
1930	1444	3434	79

Materials	
Component	Materials
Bellows	Multi-ply Virgin PTFE to ASTM D4894 Type IV
Flanges	Carbon Steel to BS1501-161-430A / P265GH Typical
Paint	Ultra-High Temperature in Silver
Root Rings	Stainless Steel to 320S31 (316Ti)
Tie Rods & Nuts	Carbon Steel Grade 8.8 Zinc Plated
Limit Sleeves	Stainless Steel to ASTM A312 Gr. 304/304L

	ASME Class 150	
	Series A	Series B
Raised Face Ø	1194mm	1130mm
Bolt Circle Ø	1257mm	1172mm
Flange Ø max	1473mm	1371mm
Bolt Holes ³ [No x Thread]	36 x 1.1/2" UNC	48 x 1" UNC
Thickness	50mm	
Effective Area	1.07m ²	

Options	
Component	Options
Bellows	Multi-ply Static-Dissipating ASTM D4894 Type IV
Flanges	Stainless Steel, Hastelloy, Low Temperature Steels etc.
Root Rings	Hastelloy, Monel etc.
Tie Rods & Nuts	Stainless steel, Hastelloy, Monel etc.
Anti-Snake Rings	Stainless Steel

Vacuum Performance

Whilst the standard bellows are not suitable for use under vacuum, they can be supplied with internal vacuum support rings to provide full vacuum performance. Vacuum support rings can be manufactured from Hastelloy, Titanium, Tantalum or PTFE encapsulated etc.

Notes:

1. Larger movements are available with more convolutions. These are not combined movements, please refer to page 7 for info.
2. Please refer to page 5 for temperature correction factors for spring rate.
3. As standard flange holes are threaded. Clearance holes are possible for certain sizes please contact us.
4. The maximum number of convolutions for this size is 6, please consult us for further information on these.
5. For operating temperature and pressure for more than 5 convolutions please contact us.

Armoured FluoroFlow FFAB PTFE PN16 Bellows are available in 2 lengths for most sizes as standard and manufactured from virgin HiPerFlon® PTFE combined with a multi-layered austenitic stainless steel shell to provide high pressure performance outside the range of conventional PTFE bellows. This range is designed to the EJMA international standard.

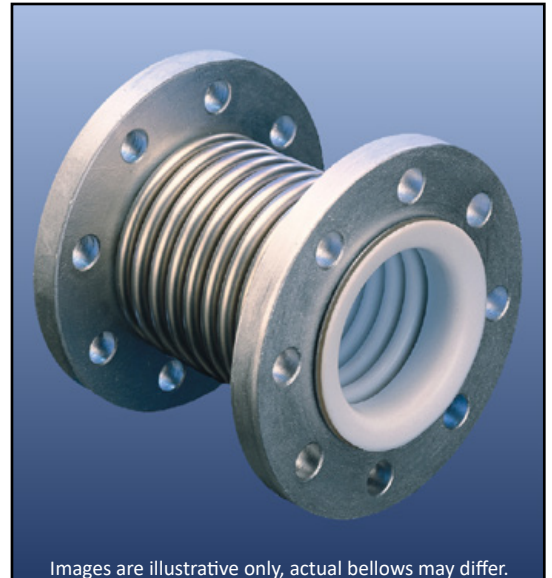
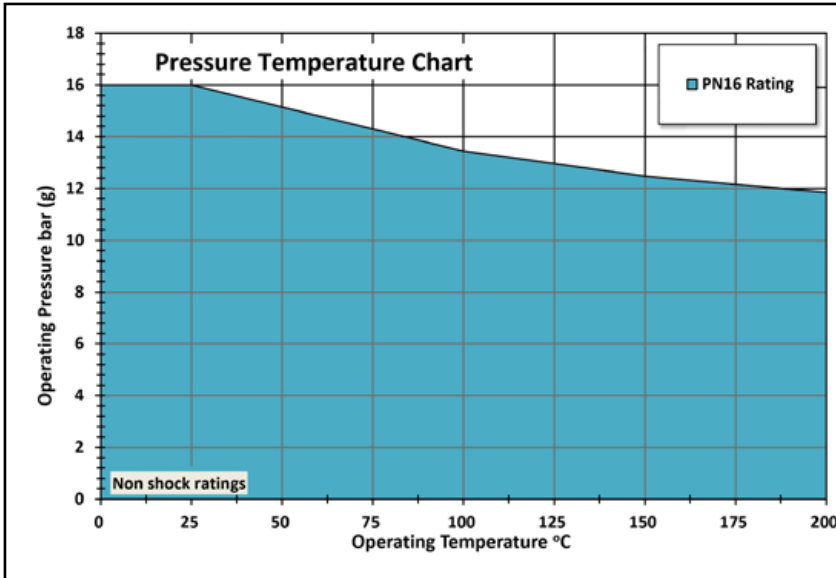

Materials	
Component	Materials
Bellows Liner	Paste Extruded Virgin PTFE to ASTM D4895
Bellows Shell	Stainless Steel to 321S31 /321 /1.4541
Flanges	Carbon Steel to S235JRG2 / RSt 37.2
Paint on CS flanges	Zinc Epoxy Primer, Colour Grey

Options	
Bellows Liner	Paste Extruded Static-Dissipating PTFE to ASTM D4895
Bellows Shell	Hastelloy & other Exotic Materials
Flanges	Stainless Steel, Exotics etc.
Bolt Holes	Threaded Holes UNC or Metric
Tie Rods	Available as an option

Dimensions and Movements									Weight	
NB	DN	Neutral Length [mm]	Minimum Length [mm]	Maximum Length [mm]	Lateral +/- [mm]	Angular +/- [Degrees]	Spring Rate [N/mm] ¹	Effective Area [mm ²]	DIN [Kg]	ASME [Kg]
1.1/2"	40	130	121	139	1	3	183	2780	5	3
2"	50	125	116	134	1	3	185	4220	6	5
2.1/2"	65	135	126	144	1	2	200	5900	7	7
3"	80	130	120	140	1	2	216	8510	7	8
4"	100	160	150	170	1	2	300	13830	10	12
5"	125	175	164	186	1	2	390	20080	12	14
6"	150	165	154	176	1	1	530	27900	16	17
8"	200	180	168	192	1	1	707	44800	23	27
10"	250	200	186	214	1	1	896	67700	34	38
12"	300	195	178	212	1	1	792	93900	44	59
14"	350	175	157	193	1	1	1026	110800	65	78
20"	500	220	195	245	1	1	1067	215900	149	144

Notes:

1. Spring rates are for both axial extension and compression.
2. Tie rods are not supplied as standard but are available, including with spherical washers as required.
3. For vacuum performance information please refer to page 33.

FluoroFlow FFAB Armoured PTFE Bellows DN40 / 1.1/2"NB - DN400 / 16"NB 16BARg Long Series

Armoured FluoroFlow FFAB PTFE PN16 Bellows are available in 2 lengths for most sizes as standard and manufactured from virgin HiPerFlon® PTFE combined with a multi-layered austenitic stainless steel shell to provide high pressure performance outside the range of conventional PTFE bellows. This range is designed to the EJMA international standard.

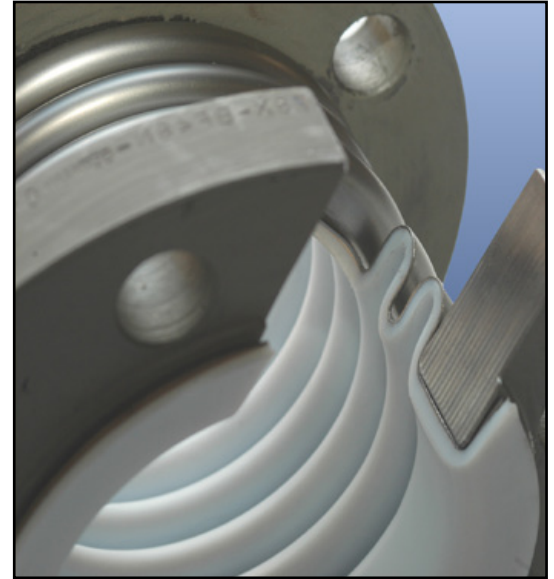
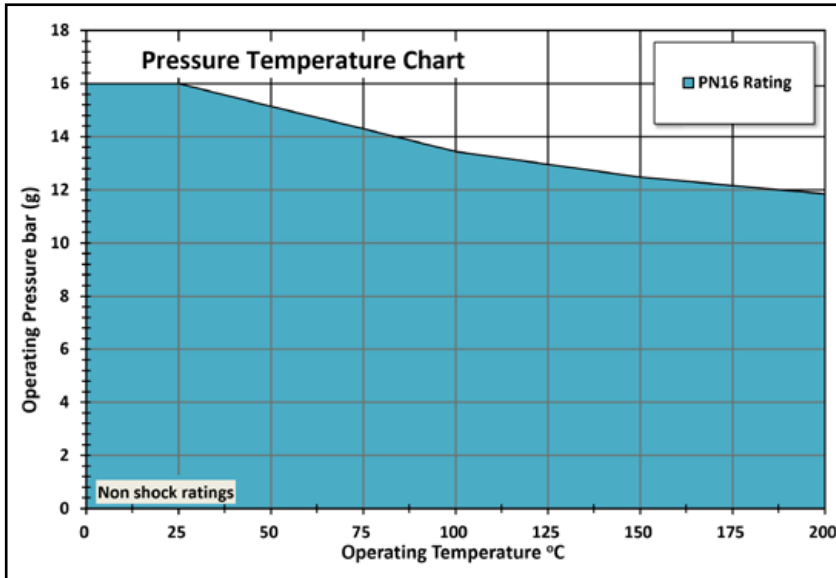

Vacuum Performance for Armoured FFAB bellows (All types pages 32-34)

Temperature / Vacuum	1.1/2" - 4"NB	5"NB	6"NB	8"NB	10"NB	12"NB	14"NB	16"NB	20"NB
	DN40 - DN100	DN125	DN150	DN200	DN250	DN300	DN350	DN400	DN500
20°C / Bar(g)	-1.0	-1.0	-1.0	-0.98	-0.95	-0.89	-0.82	0.0	0.0
100°C / Bar(g)	-1.0	-1.0	-1.0	-0.95	-0.87	-0.77	-0.64	0.0	0.0
180°C / Bar(g)	-1.0	-0.97	-0.95	-0.88	-0.77	-0.64	-0.47	0.0	0.0

Dimensions and Movements

Dimensions and Movements									Weight	
NB	DN	Neutral Length [mm]	Minimum Length [mm]	Maximum Length [mm]	Lateral +/- [mm]	Angular +/- [Degrees]	Spring Rate [N/mm]	Effective Area [mm ²]	DIN [Kg]	ASME [Kg]
1.1/2"	40	225	210	240	1	3	138	2720	5	3
2"	50	215	200	230	1	3	145	4150	6	5
2.1/2"	65	215	197	233	1	2	214	5700	8	8
3"	80	220	201	239	1	2	202	8400	9	10
4"	100	260	239	281	1	2	179	13700	11	13
5"	125	270	247	293	1	2	237	19900	14	16
6"	150	300	274	326	1	1	216	28000	16	17
8"	200	325	292	358	1	1	303	44550	25	30
10"	250	330	296	364	1	1	376	67700	35	40
12"	300	350	310	390	1	1	338	93900	46	61
14"	350	315	271	359	1	1	484	110800	68	80
16"	400	335	287	383	1	1	445	143700	96	114

Notes:

1. Spring rates are for both axial extension and compression.
2. Tie rods are not supplied as standard but are available, including with spherical washers as required.

Armoured FluoroFlow FFAB PTFE PN25 Bellows are manufactured from virgin HiPerFlon® PTFE combined with a multi-layered austenitic stainless steel shell to provide high pressure performance outside the range of conventional PTFE bellows. This range is designed to the EJMA international standard.

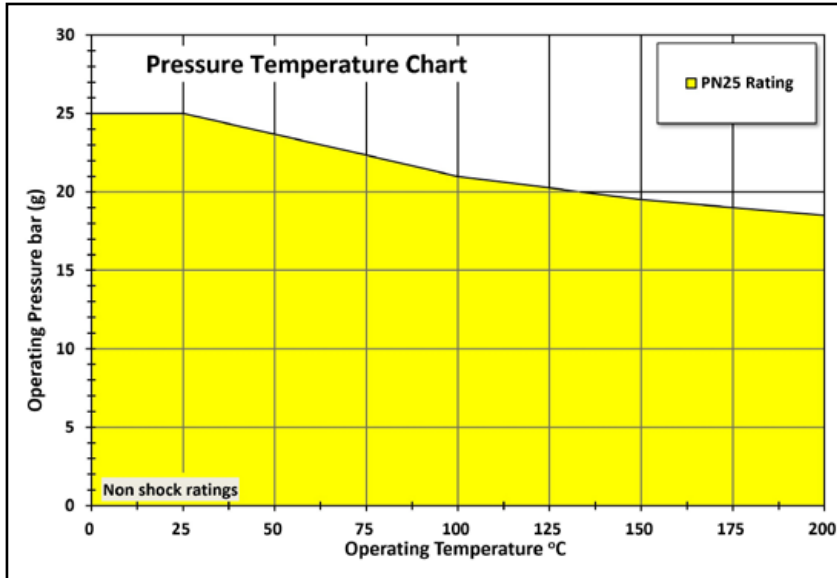

Materials	
Component	Materials
Bellows Liner	Paste Extruded Virgin PTFE to ASTM D4895
Bellows Shell	Stainless Steel to 321S31 /321 /1.4541
Flanges	Carbon Steel to S235JRG2 / RSt 37.2
Paint on CS flanges	Zinc Epoxy Primer, Colour Grey

Options	
Bellows Liner	Paste Extruded Static-Dissipating PTFE to ASTM D4895
Bellows Shell	Hastelloy & other Exotic Materials
Flanges	Stainless Steel, Exotics etc.
Bolt Holes	Threaded Holes UNC or Metric
Tie Rods	Available as an option

Dimensions and Movements									Weight	
NB	DN	Neutral Length [mm]	Minimum Length [mm]	Maximum Length [mm]	Lateral +/- [mm]	Angular +/- [Degrees]	Spring Rate [N/mm] ¹	Effective Area [mm ²]	DIN [Kg]	ASME [Kg]
1.1/2"	40	260	246	274	1	3	265	2620	6	7
2"	50	240	225	255	1	3	276	4010	8	8
2.1/2"	65	230	214	246	1	2	274	5660	10	12
3"	80	225	209	241	1	2	245	8310	12	15
4"	100	220	203	237	1	2	280	13580	17	25
5"	125	300	280	320	1	2	356	19630	28	35
6"	150	295	275	315	1	1	407	27460	32	43
8"	200	230	217	243	1	1	750	44340	40	61
10"	250	330	303	357	1	1	624	67200	68	92
12"	300	345	312	378	1	1	597	92630	88	136
DN350 PN25		315	280	350	1	1	661	109700	120	n/a
14" Class 300		335	300	370	1	1	661	109700	n/a	170
DN400 PN25		330	293	367	1	1	859	143200	158	n/a
16" Class 300		350	313	387	1	1	859	143200	n/a	209
20"	500	300	268	332	1	1	1095	217500	219	290

Notes:

1. Spring rates are for both axial extension and compression.
2. Tie rods are not supplied as standard but are available, including with spherical washers as required.
3. For vacuum performance please refer to page 33.

Bellows Specifier Cut Sheet



PTFE Bellows need to be specified accurately to perform safely and have a long life. Beyond the basics of nominal bore size, media, temperature and pressure, the movements required from the bellows are critical. The individual data sheets for each bellows size provide the data for our standard products. If this does not suit your application then please contact us with the information below and allow us to help.

Customer Name Media

Operational Information

Minimum Operating Temperature °C Maximum Operating Temperature °C
 Minimum Operating Pressure bar (g) Maximum Operating Pressure bar (g)
 Vacuum bar (g) Bellows NB / DN " / mm

Mechanical Requirements

Neutral Length mm
 Movements Axial mm Lateral mm Angular °

Are the movements ever combined at the same time? If so please identify the maximum combined movements.

Combined Movements Axial mm Lateral mm Angular °

Bellows Type

Armoured PTFE Bellows
 Standard 3 Convolution Bellows or Number of Convolutions Signifies standard product
HiPerFlon® PTFE
 HiPerFlon® Virgin PTFE HiPerFlon® Static-Dissipating PTFE

Flange Material

Carbon Steel Stainless Steel Other

Flange Drillings

ASME B16.5 Class 150 DIN PN10 Other

Tie Rods

Carbon Steel, Zinc Plated Stainless Steel Other

Root Rings

316Ti Stainless Steel Hastelloy Other

Vacuum Support Rings

Stainless Steel PTFE Lined Hastelloy Other

Options

Smoothbore Sleeve Safety Shield (Strongly Recommended)

Certification

EN10204 Type 2.2 EN10204 Type 3.1

Other Remarks



CRP Ltd
Todmorden Road
Littleborough
OL15 9EG
United Kingdom
Tel: +44 (0)1706 756400
email: enquiry@crp.co.uk

www.crp.co.uk
www.ptfebellows.com

This information is for general guidance only, no warranty is given for its accuracy and CRP reserve the right to change specifications with notice © CRP.

crp
the corrosion expert
Europe Bellows Issue 18